

• 15G0010B1 •

PROFdrive

COMMUNICATIONS BOARD

USER MANUAL -Installation and Programming Instructions-

Updated on 24/06/08
R. 00

English

- This manual is integrant and essential to the product. Carefully read the instructions contained herein as they provide important hints for use and maintenance safety.
- This device is to be used only for the purposes it has been designed to. Other uses should be considered improper and dangerous. The manufacturer is not responsible for possible damages caused by improper, erroneous and irrational uses.
- Elettronica Santerno is responsible for the device in its original setting.
- Any changes to the structure or operating cycle of the device must be performed or authorized by the Engineering Department of Elettronica Santerno.
- Elettronica Santerno assumes no responsibility for the consequences resulting by the use of non-original spare-parts.
- Elettronica Santerno reserves the right to make any technical changes to this manual and to the device without prior notice. If printing errors or similar are detected, the corrections will be included in the new releases of the manual.
- Elettronica Santerno is responsible for the information contained in the original version of the Italian manual.
- The information contained herein is the property of Elettronica Santerno and cannot be reproduced. Elettronica Santerno enforces its rights on the drawings and catalogues according to the law.



Elettronica Santerno S.p.A.
Strada Statale Selice, 47 – 40026 Imola (BO) Italy
Tel. +39 0542 489711 – Fax +39 0542 489722
www.elettronicasanterno.com sales@elettronicasanterno.it

0. TABLE OF CONTENTS

0.	TABLE OF CONTENTS	2
0.1.	Figures	3
0.2.	Tables	3
1.	INTRODUCTION	4
1.1.	INTENDED AUDIENCE	4
1.2.	BEFORE YOU START	4
1.3.	WHAT THIS MANUAL CONTAINS	4
1.4.	TERMS USED IN THIS MANUAL	5
1.4.1.	Communication Module	5
1.4.2.	Data Sets and Data Words	5
1.4.3.	PROFIdrive Communications Board	5
1.4.4.	Parameter	5
1.5.	FURTHER INFORMATION	5
2.	SAFETY INSTRUCTIONS	6
2.1.	OVERVIEW	6
2.2.	GENERAL SAFETY INSTRUCTIONS	6
3.	OVERVIEW	7
3.1.	DESCRIPTION	7
3.2.	PROFIBUS STANDARD	7
3.3.	THE PROFIdrive COMMUNICATIONS BOARD	8
3.4.	COMPATIBILITY	9
3.5.	DELIVERY CHECK	9
4.	QUICK START-UP GUIDE	10
4.1.	OVERVIEW	10
4.2.	PLC CONFIGURATION	10
4.3.	MECHANICAL AND ELECTRICAL INSTALLATION	13
4.4.	DRIVE CONFIGURATION	13
4.5.	PARAMETER SETTING EXAMPLES	13
5.	PROGRAMMING	15
5.1.	OVERVIEW	15
5.2.	CONFIGURING THE SYSTEM	15
5.3.	PROFIBUS CONNECTION CONFIGURATION	15
5.4.	CONTROL LOCATIONS	18
6.	DP-V0 COMMUNICATION	19
6.1.	OVERVIEW	19
6.2.	PROFIBUS DP	19
6.3.	SERVICE ACCESS POINTS	19
6.4.	COMMUNICATION START-UP	19
6.5.	PPO MESSAGE TYPES	26
6.6.	THE CONTROL WORD AND THE STATUS WORD	27
6.7.	REFERENCES	27
6.8.	ACTUAL VALUES	28
6.9.	PARAMETER HANDLING IN CYCLIC COMMUNICATION (DP)	32
7.	DP-V1 COMMUNICATION	41
7.1.	OVERVIEW	41
7.2.	PROFIBUS DP	41
7.3.	SERVICE ACCESS POINTS	41
7.4.	COMMUNICATION START-UP	41
7.5.	PPO MESSAGE TYPES	51

7.6.	THE CONTROL WORD AND THE STATUS WORD	52
7.7.	REFERENCES.....	52
7.8.	ACTUAL VALUES.....	53
8.	FAULT TRACING	70
8.1.	LED INDICATIONS.....	70
9.	PROFIDRIVE PARAMETERS.....	71
10.	DEFINITIONS AND ABBREVIATIONS.....	74
10.1.	PROFIBUS DEFINITIONS	74
10.2.	PROFIBUS ABBREVIATIONS	76
11.	TECHNICAL DATA.....	78
11.1.	PROFdrive COMMUNICATIONS BOARD.....	78
11.2.	PROFIBUS LINK.....	79

0.1. Figures

Figure 1:	Installing the PROFdrive GSD file.	10
Figure 2:	Selecting the operation mode.	11
Figure 3:	Setting the PPO type, baud rate and node number.....	12
Figure 4:	PPO message types.....	26
Figure 5:	The PROFdrive state machine.....	31
Figure 6:	PPO message types.....	51
Figure 7:	The PROFdrive state machine.....	56
Figure 8:	PROFIBUS SD2 telegram.	58

0.2. Tables

Table 1:	Generic drive profile (PROFdrive) with PPO Type 1.	13
Table 2:	Vendor-specific 1 profile with PPO Type 2.	14
Table 3:	The PROFdrive board configuration parameters.....	16
Table 4:	The Control Word (PROFIBUS Parameter 967).....	29
Table 5:	The Status Word (PROFIBUS Parameter 968).	30
Table 6:	The Control Word (PROFIBUS Parameter 967).....	54
Table 7:	The Status Word (PROFIBUS Parameter 968).	55
Table 8:	DP-V1 function numbers- byte DU0.....	59
Table 9:	DP-V1 error response.	59
Table 10:	DP-V1 error response: Error codes – byte DU2.	60
Table 11:	PROFdrive Request header.....	61
Table 12:	PROFdrive Response header.	62
Table 13:	Data types for Format field.	62
Table 14:	PROFdrive Parameter Request error codes.	64
Table 15:	PROFdrive profile-specific parameters.	73

1. INTRODUCTION

1.1. INTENDED AUDIENCE

The manual is intended for the people who are responsible for commissioning and using a PROFdrive communications board. The reader is expected to have a basic knowledge of electrical fundamentals, electrical wiring practices and how to operate the drive.

1.2. BEFORE YOU START

It is assumed that the drive is installed and ready to operate before starting the installation of the extension module.

In addition to conventional installation tools, have the drive manuals available during the installation as they contain important information not included in this manual. The drive manuals are referred to at various points of this document.

1.3. WHAT THIS MANUAL CONTAINS

This manual contains information on the wiring, configuration and use of the PROFdrive communications board.

Safety instructions are featured in the first few pages of this manual.

Overview contains a short description of the PROFIBUS protocol and the PROFdrive communications board, a delivery checklist, and information on the manufacturer's warranty.

Quick start-up guide contains a short description of how to set up PROFdrive communications board.

Mechanical installation contains placing and mounting instructions for the module.

Electrical installation contains wiring, bus termination and earthing instructions.

Programming explains how to program the master station and the drive before the communication through the adapter module can be started.

DP-V0 communication contains a description of how data is transmitted through the PROFdrive communications board using the PROFIBUS-DP (DP-V0) protocol.

DP-V1 communication contains a description of how data is transmitted through the PROFdrive communications board using the DP-V1 extension of the PROFIBUS DP protocol.

Fault tracing explains how to trace faults with the status LEDs on the PROFdrive communications board.

PROFIBUS parameters presents the PROFIBUS Profile-specific parameters.

Definitions and abbreviations explains definitions and abbreviations concerning the PROFIBUS protocol family.

Technical data contains information on physical dimensions, configurable settings and connectors of the module and the specification of the PROFIBUS link.

1.4. TERMS USED IN THIS MANUAL

1.4.1. COMMUNICATION MODULE

Communication Module is a name for a device (e.g. a fieldbus adapter) through which the drive is connected to an external communication network (e.g. a fieldbus). The communication with the module is activated with a drive parameter.

1.4.2. DATA SETS AND DATA WORDS

Each data set consists of three 16-bit words, i.e. data words. The Control Word (sometimes called the Command Word) and the Status Word, References and Actual Values (see sections DP-V0 COMMUNICATION and DP-V1 COMMUNICATION) are types of data words; the contents of some data words are user-definable.

1.4.3. PROFIDRIVE COMMUNICATIONS BOARD

The PROFdrive communications board is one of the optional fieldbus boards available for the inverters of the Sinus PENTA series. The PROFdrive communications board is a device through which a Sinus PENTA drive is connected to a PROFIBUS network.

1.4.4. PARAMETER

A parameter is an operating instruction for the drive. Parameters can be read and programmed with the drive control panel, or through the PROFdrive communications board.

1.5. FURTHER INFORMATION

Further information is available on the World Wide Web from

www.profibus.com.

2. SAFETY INSTRUCTIONS

2.1. OVERVIEW

This chapter states the general safety instructions that must be followed when installing and operating the PROFdrive communications board.

The material in this chapter must be studied before attempting any work on, or with, the unit.

In addition to the safety instructions given below, read the complete safety instructions of the specific drive you are working on.

2.2. GENERAL SAFETY INSTRUCTIONS

**WARNING**

All electrical installation and maintenance work on the drive should be carried out by qualified electricians.

The drive and adjoining equipment must be properly earthed.

Do not attempt any work on a powered drive. After switching off the mains, always allow the intermediate circuit capacitors 5 minutes to discharge before working on the frequency converter, the motor or the motor cable. It is good practice to check (with a voltage indicating instrument) that the drive is in fact discharged before beginning work.

The motor cable terminals of the drive are at a dangerously high voltage when mains power is applied, regardless of motor operation.

There can be dangerous voltages inside the drive from external control circuits even when the drive mains power is shut off.

Exercise appropriate care when working on the unit. Neglecting these instructions can cause physical injury or death.

3. OVERVIEW

3.1. DESCRIPTION

This chapter contains a short description of the PROFIBUS standard and the PROFdrive communications board, a delivery checklist and warranty information.

3.2. PROFIBUS STANDARD

PROFIBUS is an open serial communication standard that enables data exchange between all kinds of automation components. There are three main variations of PROFIBUS:

- PROFIBUS-FMS (Fieldbus Message Specification)
- PROFIBUS-DP (Decentralised Periphery)
- PROFIBUS-PA (Process Automation).

The PROFdrive communications board supports the PROFIBUS DP protocol, including its DP-V1 extension.

The physical transmission medium of the bus is a twisted pair cable (according to the RS-485 standard). The maximum length of the bus cable is 100 to 1200 metres, depending on the selected transmission rate (see the Technical Data chapter). Up to 31 nodes can be connected to the same PROFIBUS network segment without the use of repeaters. With repeaters, it is possible to connect 127 nodes (including repeaters and master station) to the network.

In PROFIBUS communication, the master station – usually a programmable logic controller (PLC) – polls the nodes which respond and take the actions requested by the master. It is also possible to send a command to several nodes at the same broadcast; in this case the nodes do not send a response message to the master.

The PROFIBUS protocol family is specified in the IEC 61158 standard. The communication with a drive is defined in the PROFdrive Profile – The PROFIBUS Profile for Adjustable Speed Drives. For further information on PROFIBUS, refer to the above mentioned standards.

3.3. THE PROFIdrive COMMUNICATIONS BOARD

The PROFIdrive communications board is an optional device for the inverters of the Sinus PENTA series which enables the connection of the drive to a PROFIBUS network. The drive is considered as a slave on the PROFIBUS network. Through the PROFIdrive communications board, it is possible to:

- give control commands to the drive (Start, Stop, Run enable, etc.)
- feed a motor speed or torque reference to the drive
- give a process actual value or a process reference to the PID controller of the drive
- read status information and actual values from the drive
- change drive parameter values
- reset a drive fault.

The PROFIBUS commands and services supported by the PROFIdrive communications board are discussed in sections DP-V0 COMMUNICATION and DP-V1 COMMUNICATION.

Please refer to the user documentation of the drive as to which commands are supported by the drive.

The adapter module is mounted into an option slot on the motor control board of the drive. See the Hardware Manual of the drive for module placement options.

Configuration of the master station requires a type definition (GSD) file.

For DP-V0 communication, the 0401DPV0.GSD file is required.

For DP-V1 communication, the 0401DPV1.GSD file is required.

These files are available:

- on the installation CD-Rom;
- at www.elettronicasanterno.com;
- from an Elettronica Santerno's representative.

3.4. COMPATIBILITY

The PROFdrive communications board is compatible with all master stations that support the PROFIBUS DP protocol.

3.5. DELIVERY CHECK

The option package for the PROFdrive communications board contains:

- Anybus-S Profibus PROFdrive V2 interface;
- Installation CD-ROM with User Manual and GSD configuration file.

4. QUICK START-UP GUIDE

4.1. OVERVIEW

This chapter presents the steps to take during the start-up of the PROFdrive communications board. For more detailed information, see sections MECHANICAL AND ELECTRICAL INSTALLATION and PROGRAMMING elsewhere in this manual.



WARNING

Follow the safety instructions given in this manual and the **Hardware Manual** of the drive.

4.2. PLC CONFIGURATION

This chapter contains a configuration example of a SIEMENS PLC of the SIMATIC S7-300 series.

- Install the PROFdrive GSD file (e.g. 0401DPV0.GSD).

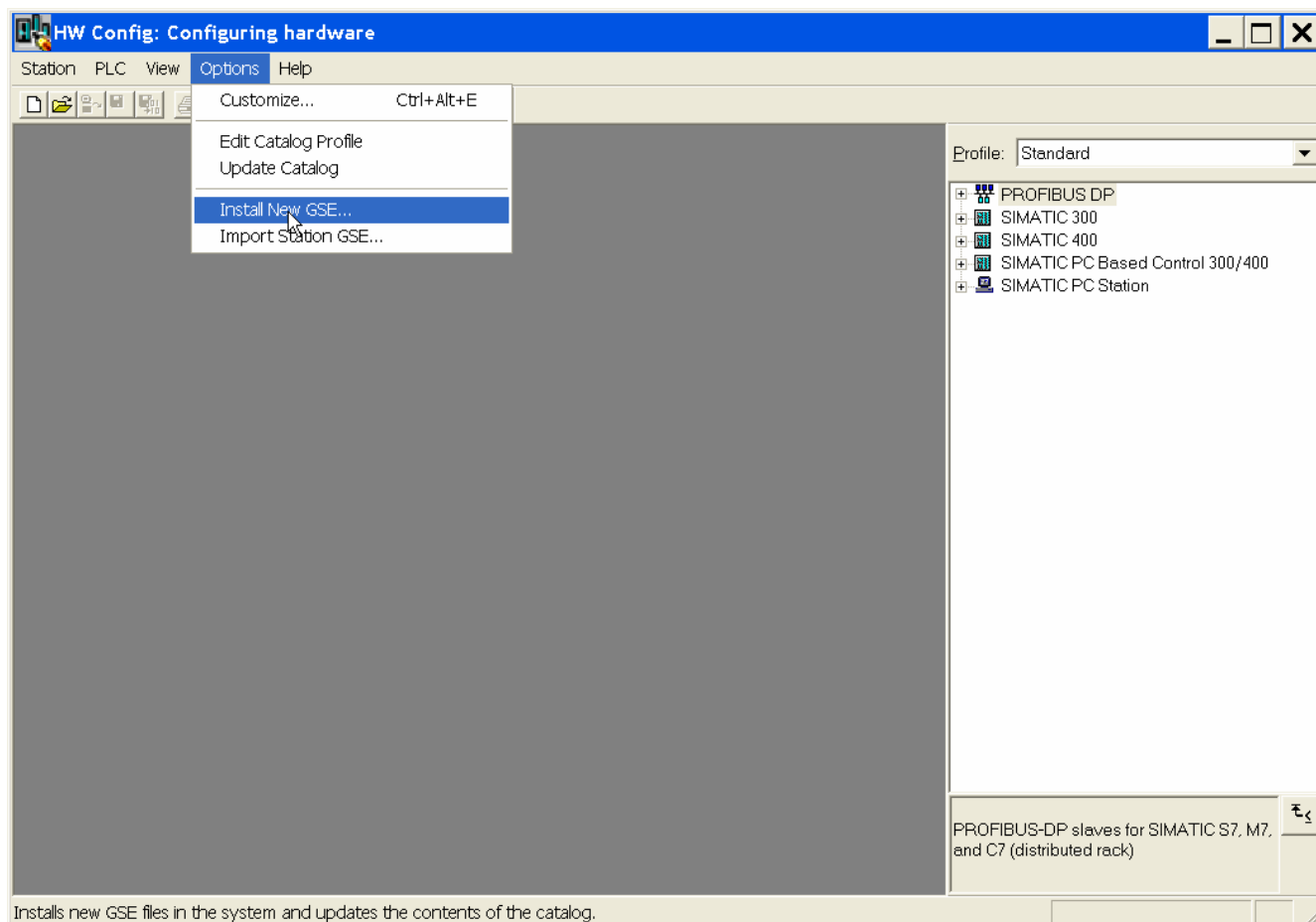

Figure 1: Installing the PROFdrive GSD file.

- Select the operation mode (PROFIDRIVE, i.e. Generic, or Vendor Specific). Correctly set Penta parameter R045.

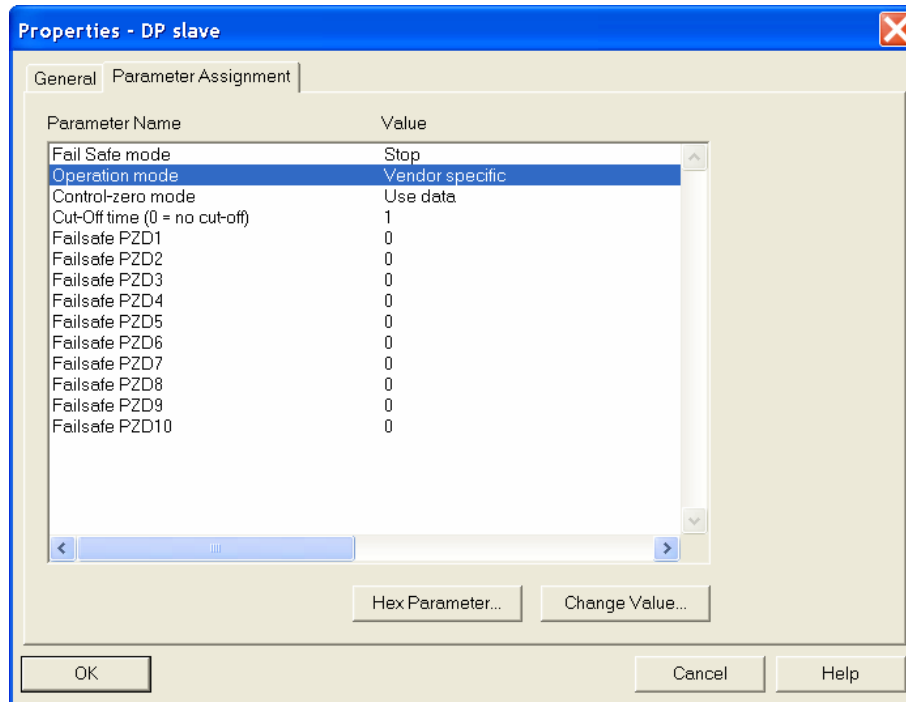

Figure 2: Selecting the operation mode.

- Set the PPO type, baud rate and node number.

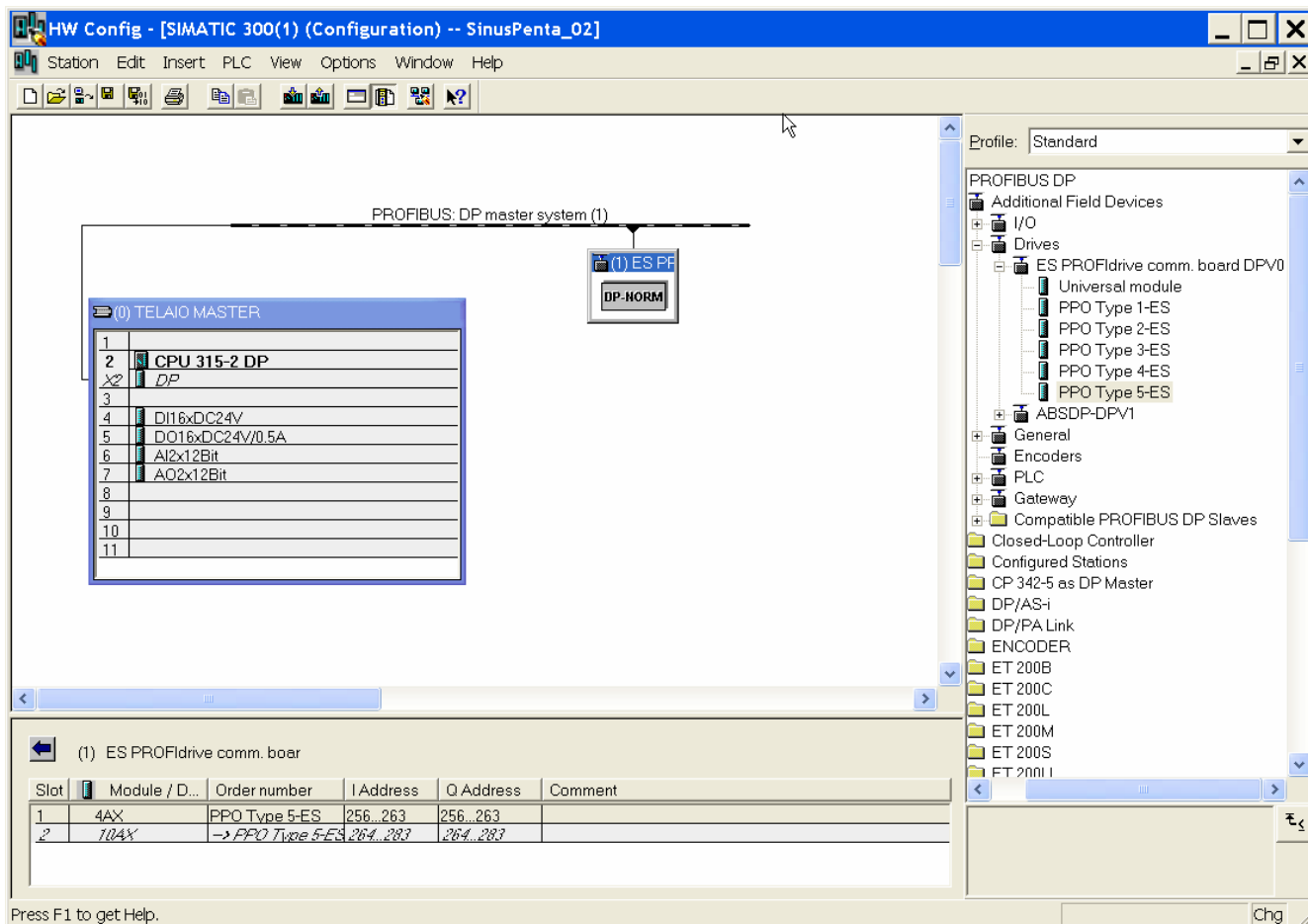

Figure 3: Setting the PPO type, baud rate and node number.

4.3. MECHANICAL AND ELECTRICAL INSTALLATION

- Set the node address using the rotary switches on the module. (If the node address is set by software, set the switches to the "0" position.)
- Set the bus termination switch to the desired position.
- Insert the PROFdrive communications board into its specified slot in the drive (SLOT B).
- Fasten the three screws.
- Plug the fieldbus connector to the module.

More detailed information is given in the "Option Boards for Fieldbus" section in the Sinus Penta's Installation Instructions manual.

4.4. DRIVE CONFIGURATION

- Power up the drive.
- Some parameters must be adjusted to activate the communication. Refer to the Programming Instructions of the drive for information on the communication settings. Set parameters **C140** and **C143** to FIELDBUS and parameter **R045** DP Selection to VENDOR SPECIFIC or GENERIC (according to PLC hardware configuration).
- If the configuration is correct (set also **R021** to Disable in the **R02x** Expansion Board Settings Menu), **R02x-R04x** PROFdrive Settings Menu should appear in the parameter list of the drive.
- If the node address is to be set by software, set the required address at parameter **R025**.

4.5. PARAMETER SETTING EXAMPLES

Drive parameter		Setting
C140	Selection of Command Source 1	3: Field Bus
C143	Selection of Reference Source 1	6: Field Bus
R025	Slave Address	3 ***
R045	Selection of drive profile	0: PROFdrive
**	MODULE TYPE	PROFIBUS DP *
**	BAUDRATE	12000 ***
**	PPO-type	PPO1*
* Read-only or automatically detected		
** Not visible		
*** Example		

Table 1: Generic drive profile (PROFdrive) with PPO Type 1.

The PROFIdrive communications board uses data-consistent communication, meaning that the whole data frame is transmitted during a single program cycle.

Some PLCs handle this internally, but others must be programmed to transmit data-consistent telegrams. For example, Siemens Simatic S7 requires the use of special functions SFC15 and SFC14.

The start/stop commands and reference are according to the PROFIdrive profile. (See the PROFIBUS state machine – Figure 5). The reference value ± 16384 (4000h) corresponds to the rated speed of the motor (parameter **C016**) in forward and reverse directions.

Drive parameter		Setting
C140	Selection of Command Source 1	3: Field Bus
C143	Selection of Reference Source 1	6: Field Bus
R025	Slave Address	3 ***
R045	Selection of Drive Profile	1: Vendor Specific 1
R026	PZD3 OUT	1: Digital Inputs ***
R027	PZD4 OUT	4: Torque Reference ***
R028	PZD5 OUT	5: PID Reference ***
R028	PZD6 OUT	6: PID Feedback ***
R034	PZD3 IN	M026 Motor Current ***
R035	PZD4 IN	M009 Torque Output ***
R036	PZD5 IN	M028 Power Output ***
R037	PZD6 IN	M029 Vbus – DC ***
**	MODULE TYPE	PROFIBUS DP *
**	BAUDRATE	12000 ***
**	PPO-type	PPO2 *
* Read-only or automatically detected		
** Not visible		
*** Example		

Table 2: Vendor-specific 1 profile with PPO Type 2.

From the PLC programming point, the Vendor Specific profile is similar to the Generic profile as shown in the first example.

The start/stop commands are according to the PROFIdrive profile (see Figure 5). On the other hand, a direct reference is sent: 1 means 1 rpm. If **C028** Minimum Motor Speed is other than 0, the value can also have a negative sign.

The minimum and maximum 16-bit integer values that can be given through the fieldbus are -32768 and 32767 respectively.

5. PROGRAMMING

5.1. OVERVIEW

This chapter gives information on configuring the PROFIBUS master station and the drive for communication through the PROFIdrive communications board.

5.2. CONFIGURING THE SYSTEM

After the PROFIdrive communications board has been mechanically and electrically installed according to the instructions given in previous chapters, the master station and the drive must be prepared for communication with the module.

For DP-V0 communication, the 0401DPV0.GSD file is required.

For DP-V1 communication, the 0401DPV1.GSD file is required.

These files are available:

- on the installation CD-Rom;
- at www.eletronicasanterno.com;
- from an Elettronica Santerno's representative.

Please refer to the master station documentation for more information.

5.3. PROFIBUS CONNECTION CONFIGURATION

The detailed procedure of activating the module for communication with the drive is dependent on the drive type. (Normally, a parameter must be adjusted to activate the communication. See the drive documentation.)

As communication between the drive and the PROFIdrive board is established, several configuration parameters are copied to the drive. These parameters – shown below in Table 5 – must be checked first and adjusted if necessary. The alternative selections for these parameters are discussed in more detail below the table.

**NOTE**

The new settings take effect only when the module is powered up the next time or when the module receives a Reset command from the drive.

Data transfer rates supported

The PROFIdrive board supports the following PROFIBUS communication speeds: 9.6 kbit/s, 19.2 kbit/s, 45.45 kbit/s, 93.75 kbit/s, 187.5 kbit/s, 500 kbit/s, 1.5 Mbit/s, 3 Mbit/s, 6 Mbit/s, 12 Mbit/s.

The PROFIdrive board automatically detects the communication speed and PPO-type used.

Par.no.	Parameter name	Alternative settings	Default setting
R025	NODE ADDRESS	0 to 126	3
1)	BAUD RATE	(12000) 12 Mbit/s; (6000) 6 Mbit/s; (3000) 3 Mbit/s; (1500) 1.5 Mbit/s; (500) 500 kbit/s; (187) 187.5 kbit/s; (93) 93.75 kbit/s; (45) 45.45 kbit/s; (19) 19.2 kbit/s; (9) 9.6 kbit/s; (Read-only)	(1500) 1.5 Mbit/s
1)	PPO-TYPE	(1) PPO 1; (2) PPO 2; (3) PPO 3; (4) PPO 4; (5) PPO 5; (6) PPO 6 (Read-only)	(1) PPO 1
R026	PZD3 OUT	See description below	0
R027	PZD4 OUT	See description below	0
...	...		
R033	PZD10 OUT	See description below	0
R034	PZD3 IN	See description below	0
R035	PZD4 IN	See description below	0
...	...		
R043	PZD10 IN	See description below	0
R044	DP Communication Mode	(0) DP-V0; (1) DP-V1	(0) DP-V0
R045	DP Selection	(0) PROFdrive; (1) Vendor Specific 1; (2) Vendor Specific 2	(1) Vendor Specific 1

Table 3: The PROFdrive board configuration parameters.

1) value is automatically updated (Read-only).



NOTE

Set also the Parameter data extended to ensure proper operation of the PROFdrive communications board with the drive.

R025 NODE ADDRESS

Each device on the PROFIBUS network must have a unique node number. This parameter is used to define a node number for the drive it is connected to, if the node address selection switches are set to the zero position. When the node address selector switches are used to define the node address (node address selectors not in zero position) this parameter indicates the set node address.

BAUD RATE

Indicates the communication speed detected in kbit/s.

12000 = 12 Mbit/s
 6000 = 6 Mbit/s
 3000 = 3 Mbit/s
 1500 = 1.5 Mbit/s
 500 = 500 kbit/s
 187 = 187.5 kbit/s
 93 = 93.75 kbit/s
 45 = 45.45 kbit/s
 19 = 19.2 kbit/s
 9 = 9.6 kbit/s

PPO-TYPE

This parameter indicates the detected PPO message type for the PROFIBUS communication. See Figure 4 and Figure 6 in sections DP-V0 COMMUNICATION and DP-V1 COMMUNICATION respectively for the supported PPO message types.

R026 PZD3 OUT

This parameter represents process data word 3 of the PPO type received by the drive over the PROFIBUS network. The content is defined by a decimal number. Its range and description are given in the Fieldbus Configuration Menu in the Programming Instructions and the application software manuals for the Sinus Penta drive.

R027 PZD4 OUT to R033 PZD10 OUT

See parameter PZD3 OUT.

R034 PZD3 IN

Process data word 3 of the PPO type sent from the drive to the PROFIBUS network. The content is defined by a decimal number. Its range and description are given in the Fieldbus Configuration Menu in the Programming Instructions and the application software manuals for the Sinus Penta drive.

R035 PZD4 IN to R041 PZD10 IN

See parameter PZD3 IN.

R044 Drive Profile Communication Mode

This parameter selects the PROFIBUS protocol version (DP-V0 or DP-V1).



NOTE

For DP-V0, 0401DPV0.GSD file must be used.
 For DP-V1, 0401DPV1.GSD file must be used.

R045 Drive Profile selection

This parameter selects the control mode for the slave as described in the table below:

	Start/Stop Command	Reference
0: PROFdrive	Depends on the PROFdrive profile.	Depends on the PROFdrive profile: the reference value ± 16384 (4000h) corresponds to the rated speed of the motor.
1: Vendor Specific 1	Depends on the PROFdrive profile.	A direct reference is sent: 1 means 1 rpm.
2: Vendor-Specific 2	The eight low bits in the CONTROL WORD correspond to the eight digital inputs in the control terminal board.	A direct reference is sent: 1 means 1 rpm.

Any parameter changes take effect only after the module is restarted.

5.4. CONTROL LOCATIONS

Sinus Penta drives can receive control information from multiple sources including digital inputs, analogue inputs, the drive control panel and a communication module (e.g. PROFdrive board). Sinus Penta drives allow the user to separately determine the source for each type of control information (Start, Stop, Direction, Reference, Fault Reset, etc.). In order to give the fieldbus master station the most complete control over the drive, the communication module must be selected as source for this information. See the user documentation of the drive for information on the selection parameters.

6. DP-V0 COMMUNICATION

6.1. OVERVIEW

This chapter describes the PROFIBUS messaging used in the communication with the drive when the PROFdrive board is in DP-V0 mode.

6.2. PROFIBUS DP

The PROFdrive board supports the PROFIBUS-DP protocol according to EN 50170 standard. PROFIBUS DP is a distributed I/O system which enables the master to use a large number of peripheral modules and field devices. The data transfer is mainly cyclic: the master reads the input information from the slaves and sends the output information back to the slaves.

The PROFIBUS DP protocol uses so-called PPOs (*Parameter/Process Data Objects*) in cyclic communication. See Figure 4 for the different PPO types and their composition.

6.3. SERVICE ACCESS POINTS

The services of the PROFIBUS Data Link Layer (Layer 2) are used by PROFIBUS DP through Service Access Points (SAPs).

Precisely defined functions are assigned to individual SAPs.

For further information on Service Access Points, refer to the manual of the PROFIBUS master, PROFdrive – The PROFIBUS Profile for Adjustable Speed Drives (version 2.0), or the EN 50170 standard.

6.4. COMMUNICATION START-UP

The following Service Access Points (SAPs) are used to initiate DP communication:

SAP no.	Short Name	Name
0 (Default)	Data Exch	Transfer Input and Output Data
61	Set Prm	Send Parameter Data
62	Chk Cfg	Check Configuration Data
60	Slave Diag	Read Slave Diagnostic

SAP 61 (Set_Prm)

This SAP is used in the parameterisation of the drive.

Prm_Data (Parameter Data Standard) Type: Octet String - Length: 8											
Byte	Value	Description									
0	B8h	Station_Status									
		MSB=7 LSB=0									
		<table border="1" style="margin: auto;"> <tr> <td style="padding: 2px 10px;">1</td> <td style="padding: 2px 10px;">0</td> <td style="padding: 2px 10px;">1</td> <td style="padding: 2px 10px;">1</td> <td style="padding: 2px 10px;">1</td> <td style="padding: 2px 10px;">0</td> <td style="padding: 2px 10px;">0</td> <td style="padding: 2px 10px;">0</td> </tr> </table>		1	0	1	1	1	0	0	0
		1	0	1	1	1	0	0	0		
		Bit N.	Value	Description							
		0	0	Reserved							
		1	0								
		2	0								
		3	1	WD_On 1 = Watchdog on							
		4	1	Free_Req 1 = Slave is requested to process in freeze mode.							
5	1	Sync_Req 1 = Slave is requested to process in SYNC mode									
6	0	Unlock_Req	00 = Min TSDR and slave-related parameters can be overwritten. 10 = Slave locked for other masters. All parameters can be carried over. x1 = Slave released for other masters.								
7	1	Lock_req									
1 – 2		Watchdog Factors 1 and 2 (set by the PROFIBUS master) WdFactor1 × WdFactor2 × 10 ms = monitoring time of the slave to verify that the master is still active.									
3	0Bh	Minimum Station Delay Respond Time Time after which a slave station is allowed to send response frames to the master. Calculated by multiplying the Hex value with tBit (time required for transmitting one bit).									
4 – 5	0401h	Vendor Identification (for the Sinus Penta drive: 0401h)									
6	00h	Group Identification									
7	–	Reserved									

Prm_Data (Parameter Data Extended) Type: Octet String - Length: 23										
8	10h (default)	Station_Status MSB=7 LSB=0 <table border="1" style="margin: auto;"> <tr> <td style="padding: 5px;">0</td> <td style="padding: 5px;">0</td> <td style="padding: 5px;">0</td> <td style="padding: 5px;">1</td> <td style="padding: 5px;">0</td> <td style="padding: 5px;">0</td> <td style="padding: 5px;">0</td> <td style="padding: 5px;">0</td> </tr> </table>	0	0	0	1	0	0	0	0
		0	0	0	1	0	0	0	0	
		Bit N.	Value	Description						
		0	0	Fail-safe mode. Defines the action taken when the PLC is switched from 'RUN' to 'STOP' mode. 00 = STOP (default) 01 = LAST SPEED						
		1	0	02 = USE FAIL-SAFE. The values of the PZDs are defined by bytes 11-30 in the Prm_Data telegram.						
		2	0	Control zero Mode. Defines the action taken if a PROFIBUS telegram containing only zeros is received. 00 = USE FRAME (default). Note that, with this setting, the drive might not be stopped (if it is running) since also bit 10 (Remote Command) in the control word is zero. However, the other PZDs may still be updated, but have the value zero. 01 = IGNORE						
		3	0							
		4	1	Operation mode. Determines which control/status word and reference/actual values are used. 00 = PROFIDRIVE (i.e. Generic drive profile) 01 = VENDOR SPECIFIC (default). With this setting: <ul style="list-style-type: none"> • Fail-safe mode 'STOP' equals 'LAST SPEED'. • The control word is forwarded unchanged to the drive if the drive has a parameter for the selection of the operation mode (i.e. communication profile). • Make sure that the operation modes of the PROFdrive communications board and the drive match. 						
		5	0							
		6	0							
7	0	Reserved								
9 – 10	0-65536	Cut off time out in milliseconds.								
11 – 12	0-65536	Fail-safe, PZD1 (CW)								
13 – 14	0-65536	Fail-safe, PZD2 (REF)								
15 – 16	0-65536	Fail-safe, PZD3								

17 – 18	0-65536	Fail-safe, PZD4
19 – 20	0-65536	Fail-safe, PZD5
21 – 22	0-65536	Fail-safe, PZD6
23 – 24	0-65536	Fail-safe, PZD7
25 – 26	0-65536	Fail-safe, PZD8
27 – 28	0-65536	Fail-safe, PZD9
29 – 30	0-65536	Fail-safe, PZD10

The extended Parameter Data bytes are configured via the PROFIBUS network configuration tool. The functions are defined in the GSD file.

SAP 62 (Chk_Cfg)

SAP 62 selects the PPO type to be used. The table below gives the Hex values that must be sent to the drive to select the PPO type.

Cfg_Data (Configuration Data) Type: Octet String - Length: 4 to 28			
PPO Type	Hex Values	Description	Length in Bytes
1	F3 F1	PKW + 2 PZD	words 12
2	F3 F5	PKW + 6 PZD	words 20
3	F1	PKW + 2 PZD	words 4
4	F5	PKW + 6 PZD	words 12
5	F3 F9	PKW + 10 PZD	words 28

SAP 60 (Slave_Diag)

This SAP gives diagnostic information on the slave station.

Diag_Data (Diagnostic Data) Type: Octet String - Length: 6 (Standard) + 2 (Extended Diagnosis)																													
Byte	Value	Description																											
0	B8h	Station_Status_1 MSB=7 LSB=0 <table border="1" style="margin: auto; border-collapse: collapse;"> <tr> <td style="text-align: center;">X</td> <td style="text-align: center;">X</td> <td style="text-align: center;">X</td> <td style="text-align: center;">X</td> <td style="text-align: center;">X</td> <td style="text-align: center;">X</td> <td style="text-align: center;">X</td> <td style="text-align: center;">X</td> </tr> </table>	X	X	X	X	X	X	X	X																			
		X	X	X	X	X	X	X	X																				
		<table border="1" style="width: 100%; border-collapse: collapse;"> <thead> <tr> <th style="text-align: center;">Bit N.</th> <th style="text-align: center;">Value</th> <th style="text-align: center;">Description</th> </tr> </thead> <tbody> <tr> <td style="text-align: center;">0</td> <td style="text-align: center;">X</td> <td>Diag.Station_Non_Existing (Set by Master, reset by Slave) Slave not found</td> </tr> <tr> <td style="text-align: center;">1</td> <td style="text-align: center;">X</td> <td>Diag.Station_Not_Ready (Set by Slave) Slave not ready for data exchange</td> </tr> <tr> <td style="text-align: center;">2</td> <td style="text-align: center;">X</td> <td>Diag.Cfg_Fault (Set by Slave) Received configuration data does not match original configuration data</td> </tr> <tr> <td style="text-align: center;">3</td> <td style="text-align: center;">X</td> <td>Diag.Ext_Diag (Set by Slave) Diagnostic entry present in slave-specific diagnostic area</td> </tr> <tr> <td style="text-align: center;">4</td> <td style="text-align: center;">X</td> <td>Diag.Not_Supported (Set by Slave) Service not supported by slave</td> </tr> <tr> <td style="text-align: center;">5</td> <td style="text-align: center;">X</td> <td>Diag.Invalid_Slave_Response (Set by Master, reset by Slave) Invalid response by slave</td> </tr> <tr> <td style="text-align: center;">6</td> <td style="text-align: center;">X</td> <td>Diag.Prm_Fault (Set by Slave) Invalid parameter or parameter value</td> </tr> <tr> <td style="text-align: center;">7</td> <td style="text-align: center;">X</td> <td>Diag.Master_Lock (Set by Master, reset by Slave) Slave is parameterised by another master</td> </tr> </tbody> </table>	Bit N.	Value	Description	0	X	Diag.Station_Non_Existing (Set by Master, reset by Slave) Slave not found	1	X	Diag.Station_Not_Ready (Set by Slave) Slave not ready for data exchange	2	X	Diag.Cfg_Fault (Set by Slave) Received configuration data does not match original configuration data	3	X	Diag.Ext_Diag (Set by Slave) Diagnostic entry present in slave-specific diagnostic area	4	X	Diag.Not_Supported (Set by Slave) Service not supported by slave	5	X	Diag.Invalid_Slave_Response (Set by Master, reset by Slave) Invalid response by slave	6	X	Diag.Prm_Fault (Set by Slave) Invalid parameter or parameter value	7	X	Diag.Master_Lock (Set by Master, reset by Slave) Slave is parameterised by another master
		Bit N.	Value	Description																									
		0	X	Diag.Station_Non_Existing (Set by Master, reset by Slave) Slave not found																									
		1	X	Diag.Station_Not_Ready (Set by Slave) Slave not ready for data exchange																									
		2	X	Diag.Cfg_Fault (Set by Slave) Received configuration data does not match original configuration data																									
		3	X	Diag.Ext_Diag (Set by Slave) Diagnostic entry present in slave-specific diagnostic area																									
		4	X	Diag.Not_Supported (Set by Slave) Service not supported by slave																									
		5	X	Diag.Invalid_Slave_Response (Set by Master, reset by Slave) Invalid response by slave																									
6	X	Diag.Prm_Fault (Set by Slave) Invalid parameter or parameter value																											
7	X	Diag.Master_Lock (Set by Master, reset by Slave) Slave is parameterised by another master																											

		Station_Status_2							
		MSB=7				LSB=0			
		X	0	X	X	X	1	X	X
1	B8h	Bit N.	Value	Description					
		0	X	Diag.Prm_Req (Set by Slave) Slave requires re-configuration and re-parameterisation					
		1	X	Diag.Stat_Diag (Set by Slave) Static diagnosis. Slave (temporarily) unable to provide valid data.					
		2	1	Always set to 1 by slave					
		3	X	Diag.WD_On (Set by Slave) Watchdog on					
		4	X	Diag.Freeze_Mode (Set by Slave) Freeze command received by slave					
		5	X	Diag.Sync_Mode (Set by Slave) Sync command received by slave					
		6	0	Reserved					
		7	X	Diag.Deactivated (Set by Master, reset by Slave) Slave is inactive					

		Station_Status_3							
		MSB=7				LSB=0			
		X	0	0	0	0	0	0	0
3	B8h	Bit N.	Value						
		0	0	Reserved					
		1	0						
		2	0						
		3	0						
		4	0						
		5	0						
		6	0						
		7	X	Diag.Ext_Diag_Overflow (Set by slave)					

3	Diag.Master_Add The address of the master that parameterised this slave
4 - 5	Ident_Number (for Sinus Penta: 0401h)
6	Ext_Diag_Data The number of bytes reserved for Extended Diagnosis (including this byte) Fixed to 2
7	Ext_Diag_Data Bit 0 = Communication temporarily lost Bit 1 = Communication permanently lost Bit 2 - 7 = Not used

SAP 0 (Data_Exchange)

Allows the master to send output data to a slave station and to simultaneously request input data from the same station.

Outp_Data (Output Data) Type: Octet String - Length: 4 to 28 (depending on the selected PPO Type)
Inp_Data (Input Data) Type: Octet String - Length: 4 to 28 (depending on the selected PPO Type)

6.5. PPO MESSAGE TYPES

P000805-B

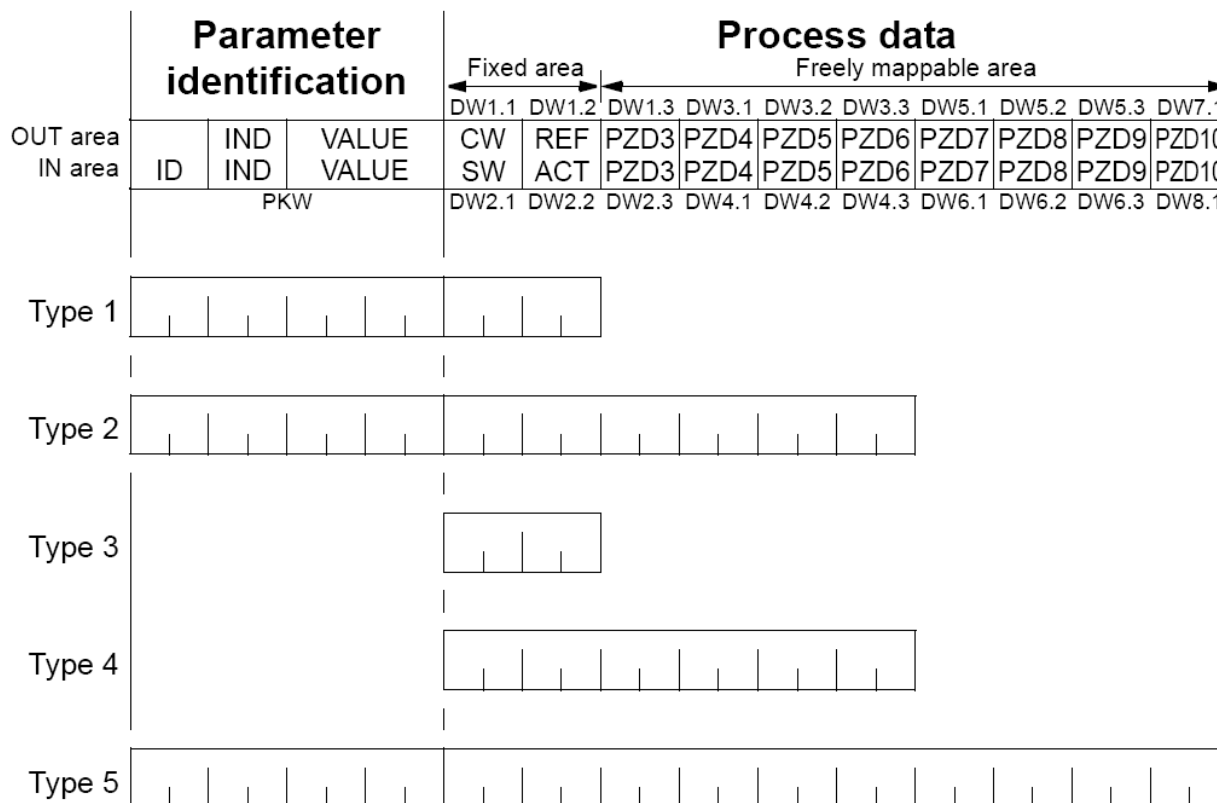

Figure 4: PPO message types.

OUT area – Data sent from Master to Slave (control data)

IN area – Data sent from Slave to Master (actual data)

Parameter Identification:

ID – Parameter Identification

IND – Index for Arrays

VALUE – Parameter Value (Max. 4 bytes)

PKW – Parameter ID/Value

Process Data:

CW – Control Word (see Table 4.)

SW – Status Word (see Table 5.)

REF – Reference

ACT – Actual Value

PZD – Process Data (application-specific)

DW – Data Word

6.6. THE CONTROL WORD AND THE STATUS WORD

The Control Word (PROFIBUS Parameter 967) is the principal means for controlling the drive from a fieldbus system. It is sent by the fieldbus master station to the drive, the adapter module acting as a gateway. The drive switches between its states according to the bit-coded instructions on the Control Word, and returns status information to the master in the Status Word (PROFIBUS Parameter 968).

The contents of the Control Word and the Status Word are detailed in Table 4 and Table 5 respectively; see the drive documentation for information on the drive-specific bits. The drive states are presented in the PROFIBUS State Machine (Figure 5).

6.7. REFERENCES

References are 16-bit words containing a sign bit and a 15-bit integer. A negative reference (indicating reversed direction of rotation) is formed by calculating the two's complement from the corresponding positive reference.

Sinus Penta drives can receive control information from multiple sources including analogue and digital inputs, the drive control panel and a communication module (e.g. PROFIdrive board). In order to have the drive controlled through PROFIBUS, the communication module must be defined as the source for control information, e.g. Reference.



In Vendor Specific modes, a direct reference is sent: 1 means 1 rpm. If **C028** Minimum Motor Speed is other than 0, the value can also have a negative sign.

In PROFIdrive mode, the speed reference (REF) in hexadecimal (0...4000h) corresponds to 0...'motor rated speed'.

6.8. ACTUAL VALUES

Actual Values are 16-bit words containing information on the operation of the drive. The functions to be monitored are selected by a drive parameter. The scaling of the integers sent to the master as Actual Values depends on the selected function, refer to the drive documentation.

In PROFdrive mode, the actual speed (ACT) in hexadecimal (0...4000h) corresponds to 0...'motor rated speed'.

Bit	Name	Value	Proceed to STATE/Description
0	ON	1	Proceed to READY TO OPERATE . "Switched on" condition; voltage at the power converter, i.e. the main contact (if any) is closed.
	OFF1	0	Emergency OFF, stop by the selected deceleration ramp. Proceed to OFF1 ACTIVE ; proceed further to READY TO SWITCH ON unless other interlocks (OFF2, OFF3) are active.
1	OFF2	1	Continue operation (OFF2 inactive) All "Coast Stop (OFF2)" commands are withdrawn.
		0	0 Emergency OFF (Coast stop). Proceed to OFF2 ACTIVE ; proceed further to SWITCH-ON INHIBIT .
2	OFF3	1	Continue operation (OFF3 inactive) All "Quick Stop (OFF3)" commands are withdrawn.
		0	Emergency stop, stop according to fastest possible deceleration mode (Quick stop). Proceed to OFF3 ACTIVE ; proceed further to SWITCH-ON INHIBIT .  WARNING Ensure motor and driven machine can be stopped using this stop mode.
3	OPERATION_ENABLE	1	Proceed to ENABLE OPERATION . Enable electronics and pulses; the drive then runs-up to the setpoint.
		0	Inhibit operation. Proceed to OPERATION INHIBIT .
4	RAMP_OUT_ZERO	1	Normal operation. Proceed to RAMP FUNCTION GENERATOR: ENABLE OUTPUT .
		0	Stop according to selected stop type.
5	RAMP_HOLD	1	Normal operation. Proceed to RAMP FUNCTION GENERATOR: ENABLE ACCELERATOR .
		0	Halt ramping (Ramp Function Generator output held).
6	RAMP_IN_ZERO	1	Normal operation. Proceed to OPERATING .
		0	Force Ramp Function Generator input to zero.  NOTE The function of this bit may depend on the ramp parameter settings of the drive. See the drive documentation.

7	RESET	0 ⇒ 1	Fault reset if an active fault exists. Proceed to SWITCH-ON INHIBIT . The group signal is acknowledged with a positive edge.
		0	Continue normal operation.
8-9			Not used.
10	REMOTE_CMD	1	Fieldbus control enabled.
		0	Control Word ≠ 0 or Reference ≠ 0: Retain last Control Word and Reference. Control Word = 0 and Reference = 0: Fieldbus control enabled.
11	WATCHDOG	1	Communication active: the watchdog counter is reset.  NOTE Fault A070 (FieldBus Watchdog) trips if Sinus Penta is not sent any Control Word with bit 11=1 within the timeout set in parameter R016 . To disable this fault, set parameter R016 to 0. The counter starts only when the drive receives the first Control Word with bit 11=1.
		0	Inactive communication: once activated, the watchdog counter increases up to the value set in R016 .
12 to 15			Not used.

Table 4: The Control Word (PROFIBUS Parameter 967).



NOTE The upper case boldface text refers to the states shown in Figure 5.

Bit	Name	Value	STATE/Description
0	RDY_ON	1	READY TO SWITCH ON
		0	NOT READY TO SWITCH ON
1	RDY_RUN 1	1	READY TO OPERATE
		0	OFF1 ACTIVE
2	RDY_REF 1	1	ENABLE OPERATION (drive follows setpoint)
		0	DISABLE OPERATION
3	TRIPPED 1	1	FAULT
		0	No fault
4	OFF_2_STA	1	OFF2 (Coast Stop) inactive
		0	OFF2 (Coast Stop) ACTIVE
5	OFF_3_STA 1	1	OFF3 (Quick Stop) inactive
		0	OFF3 (Quick Stop) ACTIVE

6	SWC_ON_INHIB	1	SWITCH-ON INHIBIT ACTIVE
		0	SWITCH-ON INHIBIT NOT ACTIVE
7	ALARM	1	Warning/Alarm
		0	No Warning/Alarm
8	AT_SETPOINT	1	OPERATING. Actual speed equals reference value (i.e. is within tolerance limits)
		0	Actual speed differs from reference value (= is outside tolerance limits)
9	REMOTE	1	Control Requested (Control By PLC): at least one between Selection of Command Source (C140..C142) and Selection of Reference Source (C143..C146) is sent from Fieldbus
		0	No Control Requested (No Control By PLC)
10 to 15			Not used.

Table 5: The Status Word (PROFIBUS Parameter 968).



NOTE The upper case boldface text refers to the states shown in Figure 5.



NOTE When the ENABLE contact in the terminal board opens (this contact is required for the operation of the Sinus Penta), the state allocated to bit 6 - **SWITCH-ON INHIBIT ACTIVATED** is enabled.

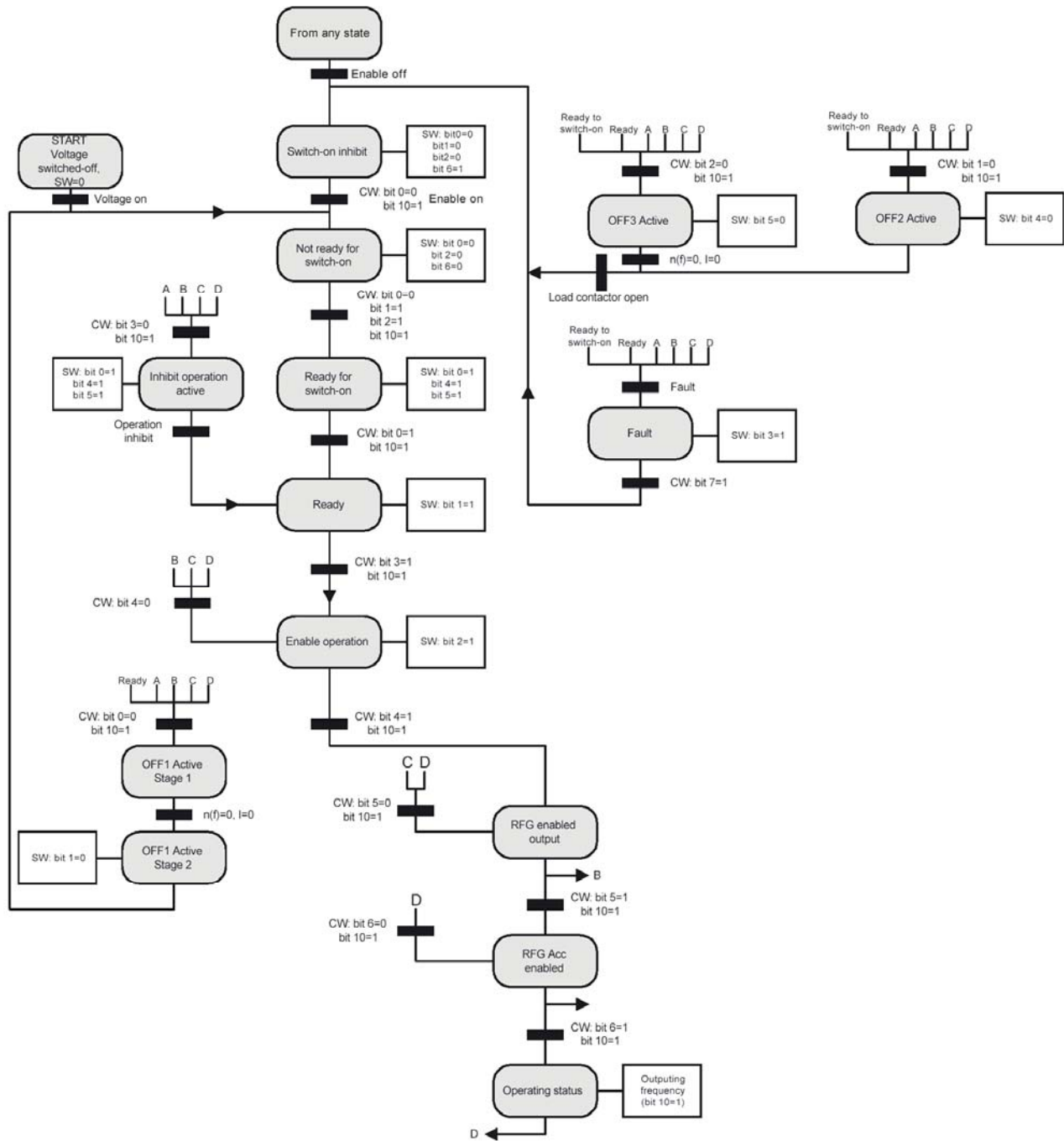

P000801-B

Figure 5: The PROFdrive state machine.

6.9. PARAMETER HANDLING IN CYCLIC COMMUNICATION (DP)

In cyclic PROFIBUS DP communication, parameter data is transferred in PPO message types 1, 2 and 5 (see Figure 4). The Parameter Identification part consists of eight bytes (see below).

P000806-B

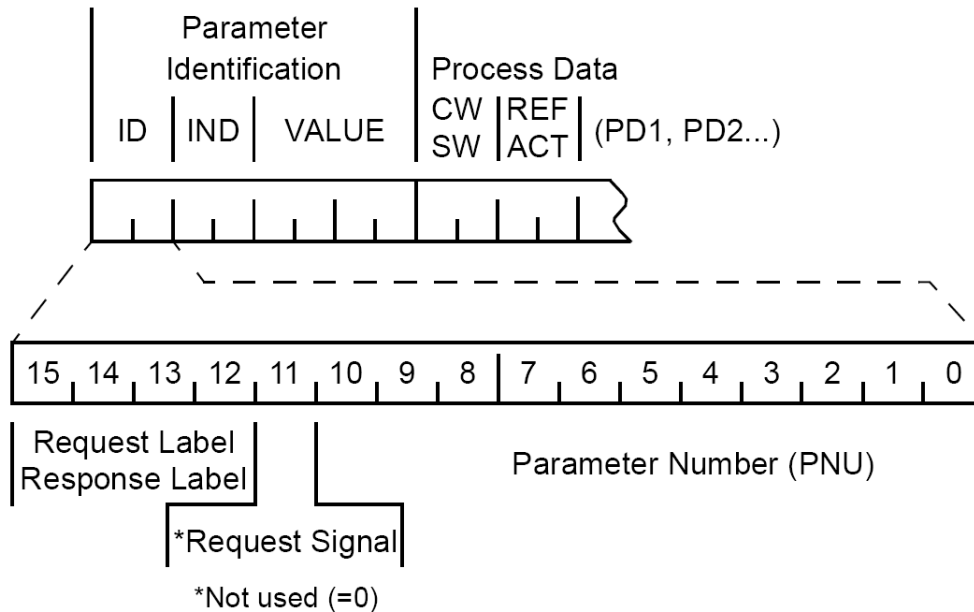

The Request Label is used by the master when transmitting data to the slave, while the Response Label is used by the slave as a positive or negative acknowledgement. The tables below show the Request/Response functions.

Request labels (from Master to Slave)			
Request	Function	Response labels	
		Ackn. (+)	Ackn. (-)
0	No task	0	-
1	Request parameter value	1, 2	7
2	Change parameter value (word)	1	7, 8
3	Change parameter value (double word) (not supported)	2	7, 8
4	Request description element (not supported)	3	7
5	Change description element (not supported)	3	7, 8
6	Request parameter value (array)	4, 5	7, 8
7	Change parameter value (array word)	4	7, 8
8	Change parameter value (array double word) (not supported)	5	7, 8
9	Request number of array elements	6	7

Response label (Acknowledgement from Slave to Master)	
Ackn.	Function
0	No response
1	Transfer parameter value (word)
2	Transfer parameter value (double word) (not supported)
3	Transfer description element (not supported)
4	Transfer parameter value (array word)
5	Transfer parameter value (array double word) (not supported)
6	Transfer number of array elements
7	Task cannot be executed, followed by error number 0 = Illegal parameter number 1 = Parameter value cannot be changed 2 = Lower or upper limit violated 3 = Erroneous subindex 4 = No array 5 = Incorrect data type 6 = Setting not allowed (can only be reset) 7 = Descriptive element cannot be changed 9 = Descriptive data not available 11 = No parameter change rights 15 = Text array not available 17 = Task cannot be executed due to operating status (e.g. parameter is currently read-only) 18 = Other error 101 = Vendor specific error 102 = Request not supported 103 = Request cannot be completed due to communication error 110 = Failure during write to non-volatile memory 111 = Request aborted due to time-out 120 = Parameter cannot be mapped to PZD (size mismatch or non-existent) 121 = Parameter cannot be mapped to PZD (end of memory) 122 = Parameter cannot be mapped to PZD (multiple PZD write) 130 = Cannot map Control Word bit (parameter 933 - 937, e.g. double mapping of bits) 140 = Cannot change mode to TORQUE (frequency is used)
8	No parameter change rights for PKW interface
9	Parameter data signal (word) (not supported)
10	Parameter data signal (double word) (not supported)

The allocation of drive parameters and PROFdrive parameters to the Parameter Identification part of the PPO type is shown below.

The **Index** column corresponds to the parameter number (PNU) in the ID part of Parameter Identification.

The **Sub-index** column corresponds to the IND part of Parameter Identification. The **Example No.** column refers to the examples on the following pages.

Drive parameters 2.35 to 17.41					
Index	Sub-index	Range (Decimal)	Request Label		Example No.
2	35	235	R/W*	6/7	1, 2
2	36	236			
	...				
17	41	1741			

*Write access depends on drive parameter type, or operation mode.

The complete PROFdrive parameter list for the PROFdrive communications board can be found as a separate chapter elsewhere in this manual.



NOTE

Continuous (cyclic) writing of PROFdrive parameters should be avoided as the values of these parameters are stored in the flash memory of the PROFdrive board. The estimated lifetime of the flash memory is 1,000,000 program/erase cycles, and continuous writing will cause the memory to fail prematurely.

PROFdrive parameters						
Index	Sub-index	Range (Decimal)	Request Label		Example No.	
393h	2h	915	2	R/W	6/7	6
	3h		3			
			
	9h		9			
394h	2h	916	2	R/W	6/7	7
	3h		3			
			
	9h		9			
396h	0	918	R/W	1/2	3	
...						
3B3h	0h	947	1	R	6	5
	9h		9			
	11h		17			
	19h		25			
	21h		33			
	29h		41			
...						
3CBh	0h	971	R/W	1/2	4	

Example 1: Reading a drive parameter

To determine the parameter number and subindex for drive parameter reading, check for the parameter address in the drive software manual and divide it by 100.

M026 Output Current

M026	Range	
	Active	
	Address	1676
	Function	

The integer part is the parameter number (PNU), the remaining part (decimal part) is the subindex (IND).

For example, reading parameter **M026** Output Current (address = 1676) from the drive:

Parameter number is 16 (10h) and subindex is 76 (48h).

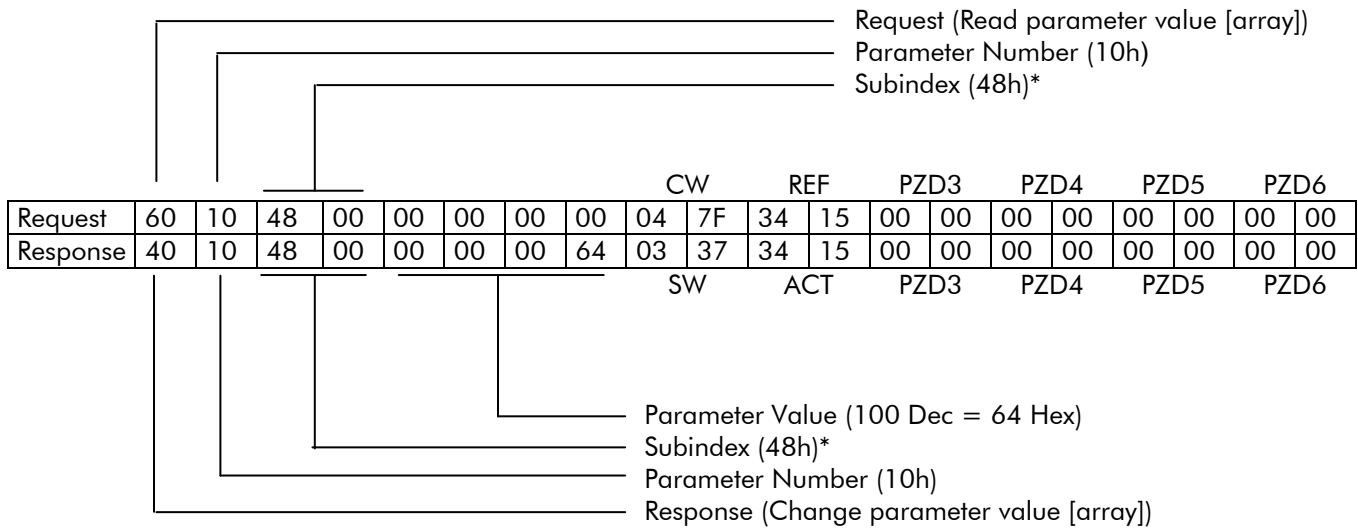

*2nd byte reserved

Example 2: Writing a drive parameter (or data set)

To determine the parameter number and subindex for drive parameter writing, check for the parameter address in the drive software manual and divide it by 100. The resulting quotient (integer part) is the parameter number (PNU) and the remaining part (decimal number) is the subindex (IND).

For example write parameter **P009** Speed Ramp 1 – Acceleration Time (address = 609) as 100 (64h):

Parameter number is 6 (06h) and subindex is 9 (09h).

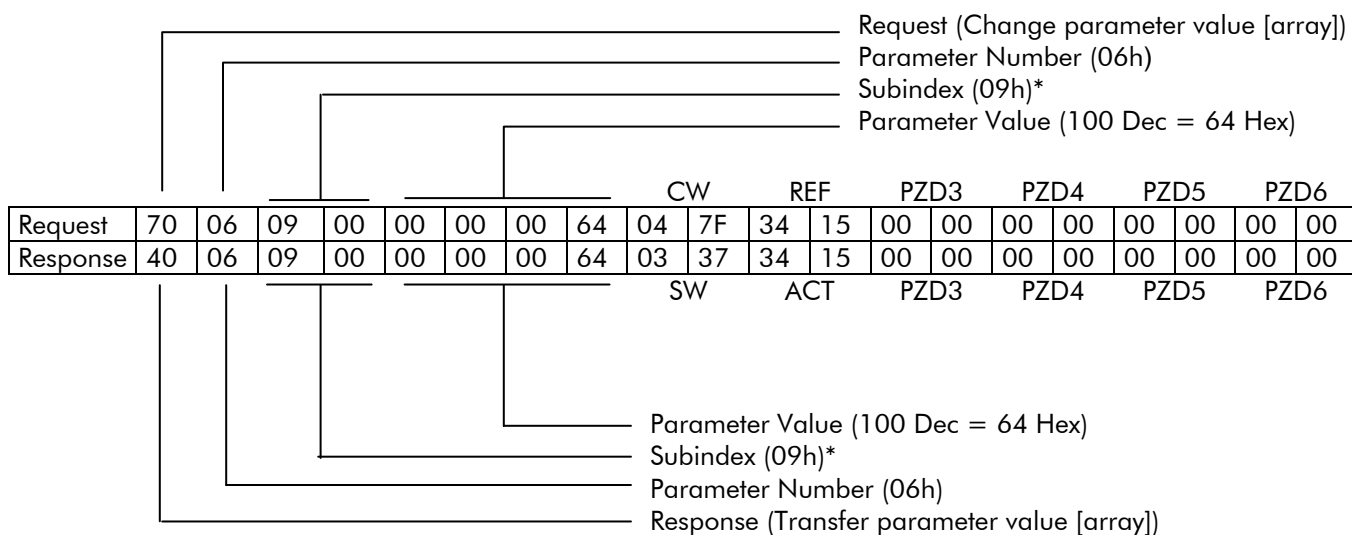

*2nd byte reserved

Example 3: Reading a PROFdrive parameter (word)

In this example, PROFIBUS Parameter No. 918 is used to read the station number of the slave.

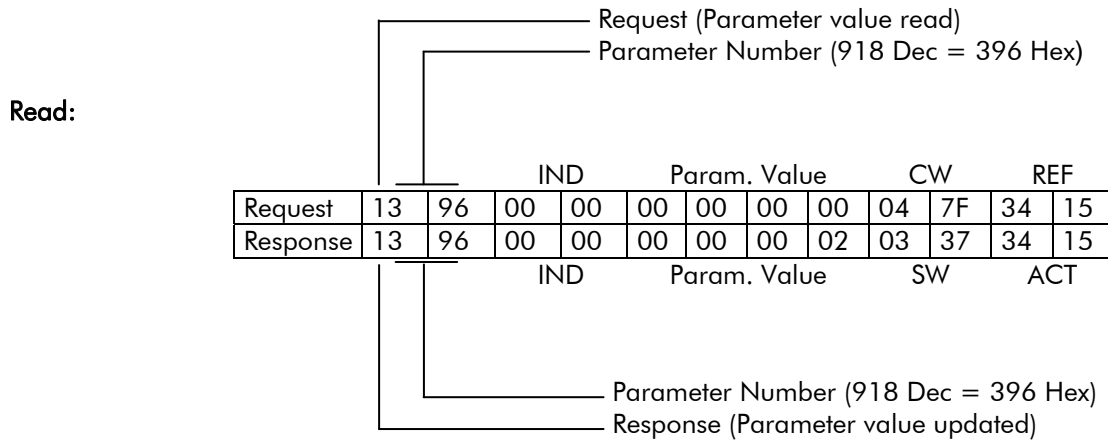

The slave returns its station number (2).

Example 4: Writing a PROFdrive parameter (word)

In this example, current parameter settings are saved to the FLASH memory of the drive. This is done by setting the value of PROFIBUS Parameter No. 971 (3CBh) to 1.

Note that the drive always observes the Control Word (CW) and Reference (REF) bytes. The values shown below are examples.

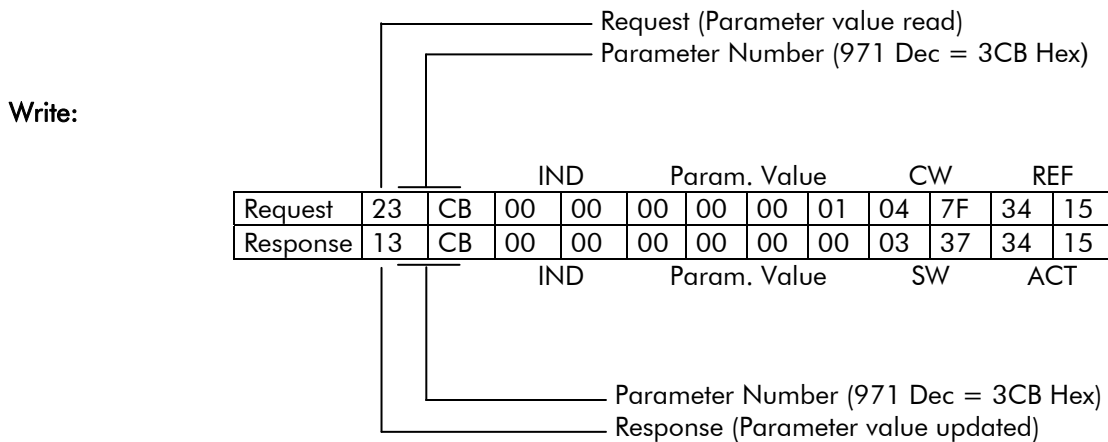

Example 5: Reading a PROFIdrive parameter (array)

In this example, PROFIBUS Parameter No. 947 is used to read the code of the latest acknowledged fault. As shown in **Table 15**, parameter 947 is of the array type with subindexes 1, 9, 17 and 25.

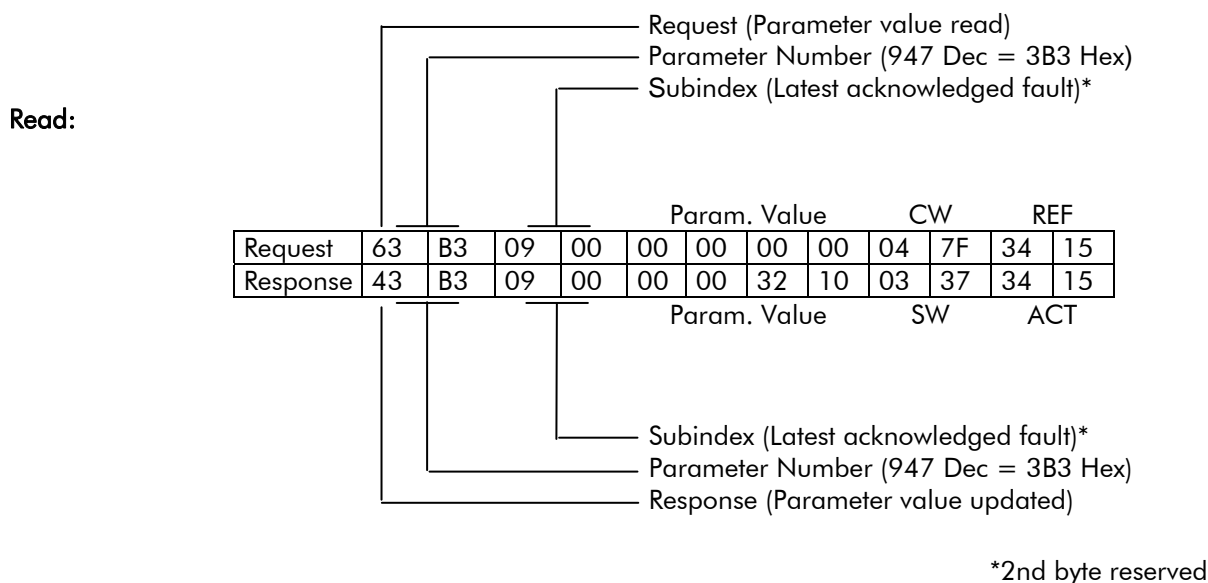

The slave returns the code of the latest acknowledged fault (3210h). The fault codes are according to the DRIVECOM standard. See also the User’s Manual of the drive for drive specific fault codes. The implementation of the PROFIdrive profile in the PROFIdrive communications board supports the storage of the active and the five latest occurred different faults in the fault buffer. The fault codes can be accessed by PROFIdrive parameter 947 (see Table 15). The value zero indicates no fault.

Example 6: Configuring the process data written to the drive

PROFIBUS parameter 915 can be used to define which data is written cyclically to a drive parameter as application-specific process data.

In the example below, the value of drive parameter **P009** Speed Ramp 1 – Acceleration Time (address = 609 = 261h) is selected to be taken from PZD3. The parameter will continue to be updated with the contents of PZD3 in each Request frame until a different selection is made.

Subindex (IND) defines which process data word the required data is taken from. *Parameter Value* selects the drive parameter to which that word is mapped.

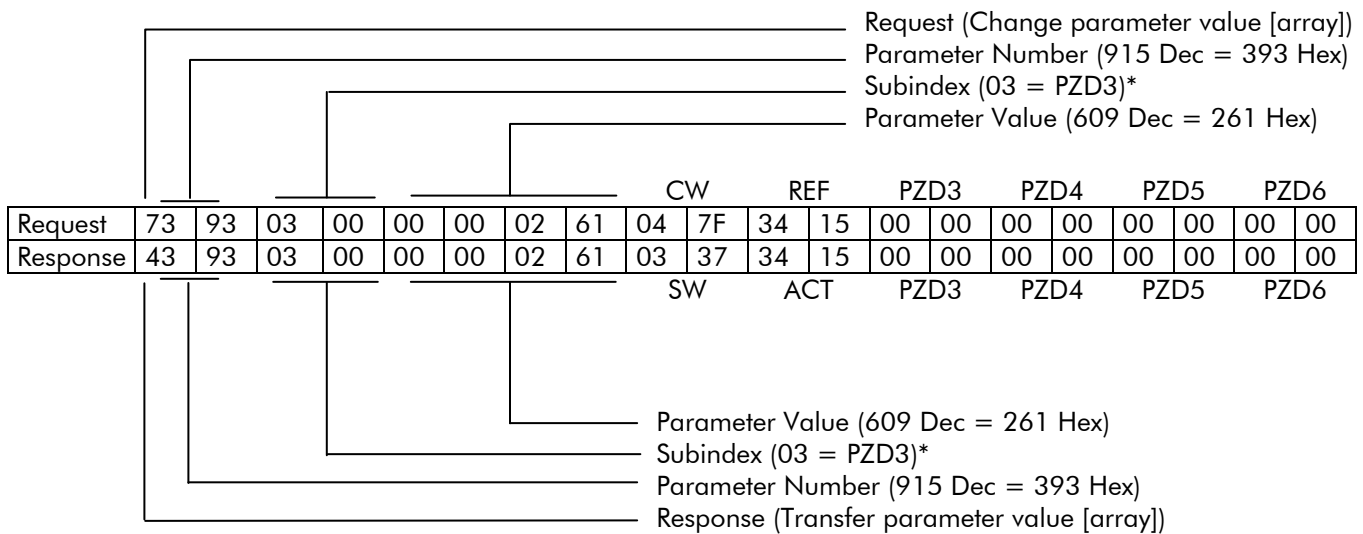

*2nd byte reserved

Subsequently, the contents of PZD3 in each Request frame are written to drive parameter 12.02 CONSTANT SPEED 1 until a different selection is made.

Example 7: Configuring the process data read from the drive

PROFIBUS Parameter No. 916 can be used to define which data is read cyclically from the drive as application-specific process data.

In the example below, drive parameter **M026** Output Current (address = 1676 = 68Ch) is selected to be transmitted by the drive as PZD3. The selection is in force until it is superseded by another selection.

Subindex (IND) defines which process data word the required data is transmitted in, and *Parameter Value* defines which drive parameter is mapped to that word.

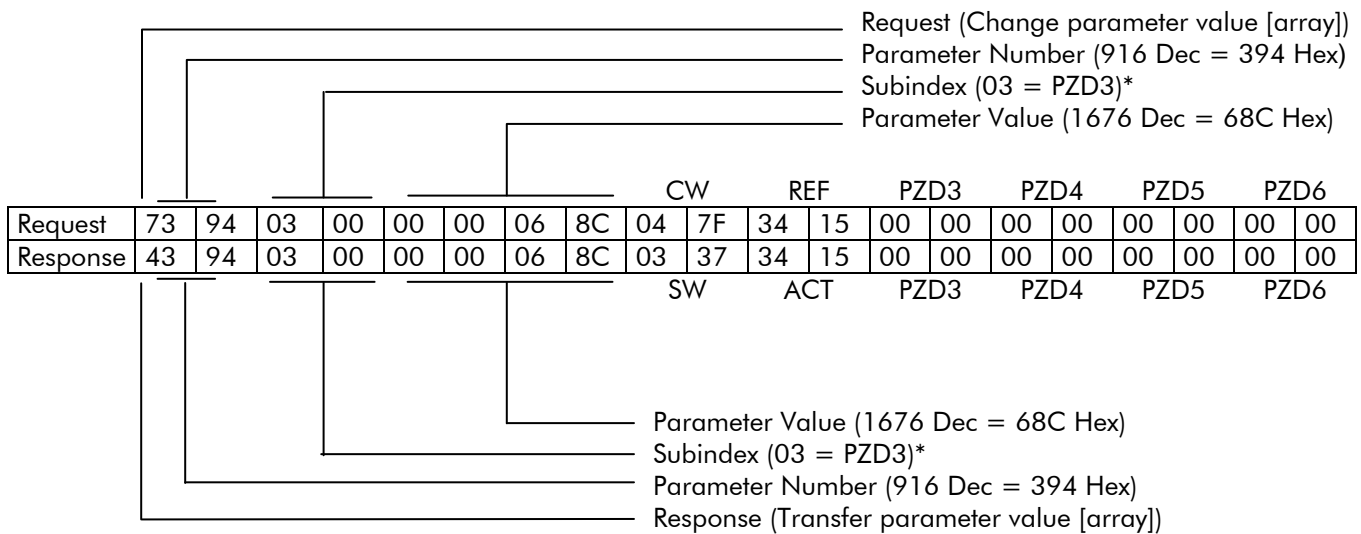

*2nd byte reserved

Subsequent response frames:

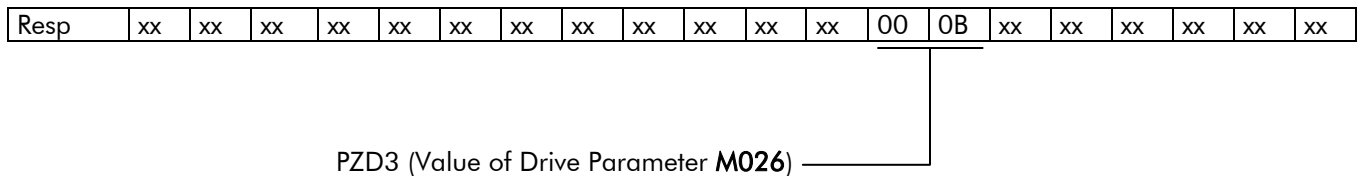

7. DP-V1 COMMUNICATION

7.1. OVERVIEW

This chapter describes the PROFIBUS messaging used in the communication with the drive when the PROFdrive board is in DP-V1 mode.

7.2. PROFIBUS DP

The PROFdrive board supports the PROFIBUS-DP protocol according to EN 50170 standard. PROFIBUS DP is a distributed I/O system which enables the master to use a large number of peripheral modules and field devices. The data transfer is mainly cyclic: the master reads the input information from the slaves and sends the output information back to the slaves.

The PROFIBUS DP protocol uses so-called PPOs (*Parameter/Process Data Objects*) in cyclic communication. See Figure 6 for the different PPO types and their composition.

7.3. SERVICE ACCESS POINTS

The services of the PROFIBUS Data Link Layer (Layer 2) are used by PROFIBUS DP through Service Access Points (SAPs).

Precisely defined functions are assigned to individual SAPs.

For further information on Service Access Points, refer to the manual of the PROFIBUS master, PROFdrive – The PROFIBUS Profile for Adjustable Speed Drives (version 2.0), or the EN 50170 standard.

7.4. COMMUNICATION START-UP

The following Service Access Points (SAPs) are used to initiate DP communication:

SAP no.	Short Name	Name
0 (Default)	Data_Exch	Transfer Input and Output Data
51	Server_SAP	Acyclic Read/Write
61	Set_Prm	Send Parameter Data
62	Chk_Cfg	Check Configuration Data
60	Slave_Diag	Read Slave Diagnostic Information

SAP 61 (Set_Prm)

This SAP is used in the parameterisation of the drive.

Prm_Data (Parameter Data Standard) Type: Octet String - Length: 8											
Byte	Value	Description									
0	B8h	Station_Status									
		MSB=7 LSB=0									
		<table border="1" style="margin: auto;"> <tr> <td style="padding: 2px 10px;">1</td> <td style="padding: 2px 10px;">0</td> <td style="padding: 2px 10px;">1</td> <td style="padding: 2px 10px;">1</td> <td style="padding: 2px 10px;">1</td> <td style="padding: 2px 10px;">0</td> <td style="padding: 2px 10px;">0</td> <td style="padding: 2px 10px;">0</td> </tr> </table>		1	0	1	1	1	0	0	0
		1	0	1	1	1	0	0	0		
		Bit N.	Value	Description							
		0	0	Reserved							
		1	0								
		2	0								
		3	1	WD_On 1 = Watchdog on							
		4	1	Free_Req 1 = Slave is requested to process in freeze mode.							
5	1	Sync_Req 1 = Slave is requested to process in SYNC mode.									
6	0	Unlock_Req	00 = Min TSDR and slave-related parameters can be overwritten. 10 = Slave locked for other masters. All parameters can be carried over. x1 = Slave released for other masters.								
7	1	Lock_req									
1 – 2		Watchdog Factors 1 and 2 (set by the PROFIBUS master) WdFactor1 × WdFactor2 × 10 ms = monitoring time of the slave to verify that the master is still active.									
3	0Bh	Minimum Station Delay Respond Time Time after which a slave station is allowed to send response frames to the master. Calculated by multiplying the Hex value with tBit (time required for transmitting one bit).									
4 – 5	0401h	Vendor Identification (for the Sinus Penta drive: 0401h)									
6	00h	Group Identification									

7	DPV1_Status_1 MSB=7 LSB=0 <table border="1" style="margin: auto; border-collapse: collapse;"> <tr> <td style="padding: 2px 10px;">X</td> <td style="padding: 2px 10px;">0</td> <td style="padding: 2px 10px;">X</td> <td style="padding: 2px 10px;">0</td> <td style="padding: 2px 10px;">0</td> <td style="padding: 2px 10px;">X</td> <td style="padding: 2px 10px;">X</td> <td style="padding: 2px 10px;">X</td> </tr> </table>			X	0	X	0	0	X	X	X
	X	0	X	0	0	X	X	X			
	Bit N.	Value	Description								
	0	X	Dis_Start_Control (Disable Start-Bit Control) 0 = Start bit monitoring in receiver enabled 1 = Start bit monitoring in receiver disabled								
	1	X	Dis_Stop_Control (Disable Stop-Bit Control) 0 = Stop bit monitoring in receiver enabled 1 = Stop bit monitoring in receiver disabled								
	2	X	WD_Base (Watchdog time base) 0 = 10 ms 1 = 1 ms								
	3	0	Reserved								
	4	0									
	5	X	Publisher_Enabled 0 = Slave not operated in DXB Publisher mode 1 = Slave operated in DXB Publisher mode (Not supported)								
	6	0	Fail_Safe. Not supported.								
7	X	DPV1_Enable 0 = Slave operated in DP mode 1 = Slave operated in DP-V1 mode									

		DPV1_Status_2							
		MSB=7				LSB=0			
		X	X	X	X	X	X	0	X
Bit N.	Value	Description							
0	X	Chk_Cfg_Mode 0 = Chk_Cfg according to EN 50170 (default state) 1 = User-specific evaluation of Chk_Cfg							
1	0	Reserved. To be parameterised with '0'.							
2	X	Enable_Update_Alarm 0 = Enable_Update_Alarm disabled 1 = Enable_Update_Alarm enabled (Not supported)							
3	X	Enable_Status_Alarm 0 = Enable_Status_Alarm disabled 1 = Enable_Status_Alarm enabled (Not supported)							
4	X	Enable_Manufacturer_Specific_Alarm 0 = Enable_Manufacturer_Specific_Alarm disabled 1 = Enable_Manufacturer_Specific_Alarm enabled (Not supported)							
5	X	Enable_Diagnostics_Alarm 0 = Enable_Diagnostics_Alarm disabled 1 = Enable_Diagnostics_Alarm enabled (Not supported)							
6	X	Enable_Process_Alarm 0 = Enable_Process_Alarm disabled 1 = Enable_Process_Alarm enabled (Not supported)							
7	X	Enable_Pull_Plug_Alarm 0 = Enable_Pull_Plug_Alarm disabled 1 = Enable_Pull_Plug_Alarm enabled (Not supported)							

9	DPV1_Status_3 MSB=7 LSB=0 <table border="1" style="margin: auto; border-collapse: collapse;"> <tr> <td style="padding: 2px 10px;">0</td> <td style="padding: 2px 10px;">0</td> <td style="padding: 2px 10px;">0</td> <td style="padding: 2px 10px;">X</td> <td style="padding: 2px 10px;">X</td> <td style="padding: 2px 10px;">X</td> <td style="padding: 2px 10px;">X</td> <td style="padding: 2px 10px;">X</td> </tr> </table>			0	0	0	X	X	X	X	X
	0	0	0	X	X	X	X	X			
	Bit N.	Value	Description								
	0	X	Alarm_Mode. Limits the number of active alarms. 0 = 1 alarm of each type 1 = 2 alarms in total								
	1	X	2 = 4 alarms in total 3 = 8 alarms in total								
	2	X	4 = 12 alarms in total 5 = 16 alarms in total 6 = 24 alarms in total 7 = 32 alarms in total								
	3	X	Prm_Structure 0 = Prm telegram according to EN 50170 1 = Prm telegram in structure form (DPV2 extension) (Not supported)								
	4	X	IsoM_Req (Isochron Mode Request) 0 = Isochron Mode disabled 1 = Isochron Mode enabled (Not supported)								
	5	0	Reserved. To be parameterised with '0'.								
	6	0									
7	0										

Prm_Data (Parameter Data Extended) Type: Octet String - Length: 23										
10	10h (default)	Header byte MSB=7 LSB=0 <table border="1" style="margin: auto;"> <tr> <td style="padding: 2px 10px;">0</td> <td style="padding: 2px 10px;">0</td> <td style="padding: 2px 10px;">0</td> <td style="padding: 2px 10px;">1</td> <td style="padding: 2px 10px;">0</td> <td style="padding: 2px 10px;">0</td> <td style="padding: 2px 10px;">0</td> <td style="padding: 2px 10px;">0</td> </tr> </table>	0	0	0	1	0	0	0	0
		0	0	0	1	0	0	0	0	
		Bit N.	Value	Description						
		0	0	Fail-safe mode. Defines the action taken when the PLC is switched from 'RUN' to 'STOP' mode. 00 = STOP (default)						
		1	0	01 = LAST SPEED 02 = USE FAIL-SAFE. The values of the PZDs are defined by bytes 11-30 in the Prm_Data telegram.						
		2	0	Control zero mode. Defines the action taken if a PROFIBUS telegram containing only zeros is received.						
		3	0	00 = USE FRAME (default). Note that, with this setting, the drive might not be stopped (if it is running) since also bit 10 (Remote Command) in the control word is zero. However, the other PZDs may still be updated, but have the value zero. 01 = IGNORE						
		4	1	Operation mode. Determines which control/status word and reference/actual values are used. 00 = PROFIDRIVE (i.e. Generic drive profile) 01 = VENDOR SPECIFIC (default). With this setting:						
		5	0	<ul style="list-style-type: none"> • Fail-safe mode 'STOP' equals 'LAST SPEED'. • The control word is forwarded unchanged to the drive if the drive has a parameter for selection of operation mode (i.e. communication profile). • Make sure that the operation modes of the PROFdrive communications board and the drive match. 						
		6	0	Reserved						
7	0									
11 - 12	0-65536	Cut off time out in milliseconds.								
13 - 14	0-65536	Fail-safe, PZD1 (CW)								
15 - 16	0-65536	Fail-safe, PZD2 (REF)								
17 - 18	0-65536	Fail-safe, PZD3								
19 - 20	0-65536	Fail-safe, PZD4								

21 - 22	0-65536	Fail-safe, PZD5
23 - 24	0-65536	Fail-safe, PZD6
25 - 26	0-65536	Fail-safe, PZD7
27 - 28	0-65536	Fail-safe, PZD8
29 - 30	0-65536	Fail-safe, PZD9
31 - 32	0-65536	Fail-safe, PZD10

The extended Parameter Data bytes are configured via the PROFIBUS network configuration tool. The functions are defined in the GSD file.

SAP 62 (Chk_Cfg)

SAP 62 selects the PPO type to be used. The table below gives the Hex values that must be sent to the drive to select the PPO type.

Cfg_Data (Configuration Data) Type: Octet String - Length: 4 to 28			
PPO Type	Hex Values	Description	Length in Bytes
1	F3 F1	PKW + 2 PZD	words 12
2	F3 F5	PKW + 6 PZD	words 20
3	F1	PKW + 2 PZD	words 4
4	F5	PKW + 6 PZD	words 12
5	F3 F9	PKW + 10 PZD	words 28
6	F9	PKW + 10 PZD	words 20

SAP 60 (Slave_Diag)

This SAP gives diagnostic information on the slave station.

Diag_Data (Diagnostic Data) Type: Octet String - Length: 6 (Standard) + 2 (Extended Diagnosis)											
Byte	Description										
0	Station_Status_1										
	MSB=7 LSB=0 <table border="1" style="margin: auto; border-collapse: collapse;"> <tr> <td style="padding: 2px 5px;">X</td> <td style="padding: 2px 5px;">X</td> <td style="padding: 2px 5px;">X</td> <td style="padding: 2px 5px;">X</td> <td style="padding: 2px 5px;">X</td> <td style="padding: 2px 5px;">X</td> <td style="padding: 2px 5px;">X</td> <td style="padding: 2px 5px;">X</td> </tr> </table>			X	X	X	X	X	X	X	X
	X	X	X	X	X	X	X	X			
	Bit N.	Value	Description								
	0	X	Diag.Station_Non_Existent (Set by Master, reset by Slave) Slave not found								
	1	X	Diag.Station_Not_Ready (Set by Slave) Slave not ready for data exchange								
	2	X	Diag.Cfg_Fault (Set by Slave) Received configuration data does not match original configuration data								
	3	X	Diag.Ext_Diag (Set by Slave) Diagnostic entry present in slave-specific diagnostic area								
	4	X	Diag.Not_Supported (Set by Slave) Service not supported by slave								
	5	X	Diag.Invalid_Slave_Response (Set by Master, reset by Slave) Invalid response by slave								
6	X	Diag.Prm_Fault (Set by Slave) Invalid parameter or parameter value									
7	X	Diag.Master_Lock (Set by Master, reset by Slave) Slave is parameterised by another master									
1	Station_Status_2										
	MSB=7 LSB=0 <table border="1" style="margin: auto; border-collapse: collapse;"> <tr> <td style="padding: 2px 5px;">X</td> <td style="padding: 2px 5px;">0</td> <td style="padding: 2px 5px;">X</td> <td style="padding: 2px 5px;">X</td> <td style="padding: 2px 5px;">X</td> <td style="padding: 2px 5px;">1</td> <td style="padding: 2px 5px;">X</td> <td style="padding: 2px 5px;">X</td> </tr> </table>			X	0	X	X	X	1	X	X
	X	0	X	X	X	1	X	X			
	Bit N.	Value	Description								
	0	X	Diag.Prm_Req (Set by Slave) Slave requires re-configuration and re-parameterisation								
1	X	Diag.Stat_Diag (Set by Slave) Static diagnosis. Slave (temporarily) unable to provide valid data									
2	1	Always set to 1 by slave									

	3	X	Diag.WD_On (Set by Slave) Watchdog on								
	4	X	Diag.Freeze_Mode (Set by Slave) Freeze command received by slave								
	5	X	Diag.Sync_Mode (Set by Slave) Sync command received by slave								
	6	0	Reserved								
	7	X	Diag.Deactivated (Set by Master, reset by Slave) Slave is inactive								
2	Station_Status_3										
	MSB=7 LSB=0										
	<table border="1" style="margin: auto;"> <tr> <td>X</td> <td>0</td> <td>0</td> <td>0</td> <td>0</td> <td>0</td> <td>0</td> <td>0</td> </tr> </table>			X	0	0	0	0	0	0	0
	X	0	0	0	0	0	0	0			
	Bit N.	Value	Description								
	0	0	Reserved								
	1	0									
	2	0									
	3	0									
	4	0									
5	0										
6	0										
7	X	Diag.Ext_Diag_Overflow (Set by Slave)									
3	Diag.Master_Add The address of the master that parameterised this slave										
4 – 5	Ident_Number (for Sinus Penta: 0401h)										
6	Header Byte										
7	Status Type = Status Message (0x81)										
8	Slot Number (0x00)										
9	Specifier (0x00)										
10	Communication Diagnostics										
	MSB=7 LSB=0										
	<table border="1" style="margin: auto;"> <tr> <td>0</td> <td>0</td> <td>0</td> <td>0</td> <td>0</td> <td>0</td> <td>X</td> <td>X0</td> </tr> </table>			0	0	0	0	0	0	X	X0
	0	0	0	0	0	0	X	X0			
Bit N.	Value	Description									
0	X	Communication temporarily lost									
1	X	Communication permanently lost									

	2	0	Reserved
	3	0	
	4	0	
	5	0	
	6	0	
	7	0	

SAP 0 (Data_Exchange)

Allows the master to send output data to a slave station and to simultaneously request input data from the same station.

Outp_Data (Output Data) Type: Octet String - Length: 4 to 28 (depending on the selected PPO Type)
Inp_Data (Input Data) Type: Octet String - Length: 4 to 28 (depending on the selected PPO Type)

7.5. PPO MESSAGE TYPES

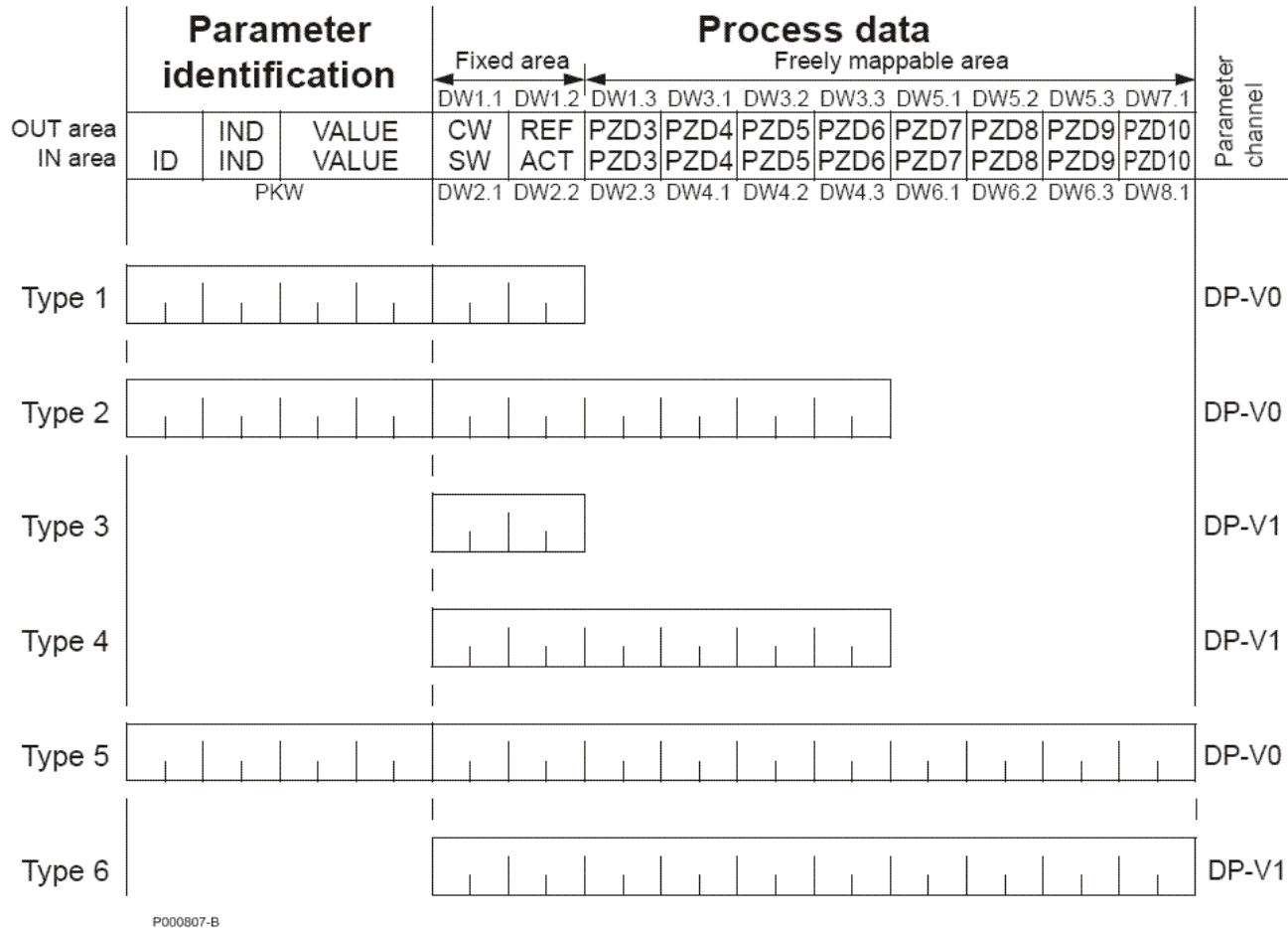

Figure 6: PPO message types.

OUT area – Data sent from Master to Slave (control data)

IN area – Data sent from Slave to Master (actual data)

Parameter Identification:

ID – Parameter Identification

IND – Index for Arrays

VALUE – Parameter Value (Max. 4 bytes)

PKW – Parameter ID/Value

Process Data:

CW – Control Word (see Table 4.)

SW – Status Word (see Table 5.)

REF – Reference

ACT – Actual Value

PZD – Process Data (application-specific)

DW – Data Word

7.6. THE CONTROL WORD AND THE STATUS WORD

The Control Word (PROFIBUS Parameter 967) is the principal means for controlling the drive from a fieldbus system. It is sent by the fieldbus master station to the drive, the adapter module acting as a gateway. The drive switches between its states according to the bit-coded instructions on the Control Word, and returns status information to the master in the Status Word (PROFIBUS Parameter 968).

The contents of the Control Word and the Status Word are detailed in Table 4 and Table 5 respectively; see the drive documentation for information on the drive-specific bits. The drive states are presented in the PROFIBUS State Machine (Figure 7).

7.7. REFERENCES

References are 16-bit words containing a sign bit and a 15-bit integer. A negative reference (indicating reversed direction of rotation) is formed by calculating the two's complement from the corresponding positive reference.

Sinus Penta drives can receive control information from multiple sources including analogue and digital inputs, the drive control panel and a communication module (e.g. PROFIdrive board). In order to have the drive controlled through PROFIBUS, the communication module must be defined as the source for control information, e.g. Reference.



In Vendor Specific modes, a direct reference is sent: 1 means 1 rpm. If **C028** Minimum Motor Speed is other than 0, the value can also have a negative sign.

In PROFIdrive mode, the speed reference (REF) in hexadecimal (0...4000h) corresponds to 0...'Motor Rated Speed'.

7.8. ACTUAL VALUES

Actual Values are 16-bit words containing information on the operation of the drive. The functions to be monitored are selected by a drive parameter. The scaling of the integers sent to the master as Actual Values depends on the selected function, refer to the drive documentation.

In PROFdrive mode, the actual speed (ACT) in hexadecimal (0...4000h) corresponds to 0...'motor rated speed'.

Bit	Name	Value	Proceed to STATE/Description
0	ON	1	Proceed to READY TO OPERATE . "Switched on" condition; voltage at the power converter, i.e. the main contact (if any) is closed.
	OFF1	0	Emergency OFF, stop by the selected deceleration ramp. Proceed to OFF1 ACTIVE ; proceed further to READY TO SWITCH ON unless other interlocks (OFF2, OFF3) are active.
1	OFF2	1	Continue operation (OFF2 inactive) All "Coast Stop (OFF2)" commands are withdrawn.
		0	0 Emergency OFF (Coast stop). Proceed to OFF2 ACTIVE ; proceed further to SWITCH-ON INHIBIT .
2	OFF3	1	Continue operation (OFF3 inactive) All "Quick Stop (OFF3)" commands are withdrawn.
		0	Emergency stop, stop according to fastest possible deceleration mode (Quick stop). Proceed to OFF3 ACTIVE ; proceed further to SWITCH-ON INHIBIT .  WARNING Ensure motor and driven machine can be stopped using this stop mode.
3	OPERATION_ENABLE	1	Proceed to ENABLE OPERATION . Enable electronics and pulses; the drive then runs-up to the setpoint.
		0	Inhibit operation. Proceed to OPERATION INHIBIT .
4	RAMP_OUT_ZERO	1	Normal operation. Proceed to RAMP FUNCTION GENERATOR: ENABLE OUTPUT .
		0	Stop according to selected stop type.
5	RAMP_HOLD	1	Normal operation. Proceed to RAMP FUNCTION GENERATOR: ENABLE ACCELERATOR .
		0	Halt ramping (Ramp Function Generator output held).
6	RAMP_IN_ZERO	1	Normal operation. Proceed to OPERATING .
		0	Force Ramp Function Generator input to zero.  NOTE The function of this bit may depend on the ramp parameter settings of the drive. See the drive documentation.



7	RESET	0 ⇒ 1	Fault reset if an active fault exists. Proceed to SWITCH-ON INHIBIT . The group signal is acknowledged with a positive edge.
		0	(Continue normal operation).
8-9			Not used.
10	REMOTE_CMD	1	Fieldbus control enabled.
		0	Control Word ≠ 0 or Reference ≠ 0: Retain last Control Word and Reference. Control Word = 0 and Reference = 0: Fieldbus control enabled.
11	WATCHDOG	1	Communication active: the watchdog counter is reset. Fault A070 (FieldBus Watchdog) trips if Sinus Penta is not sent any Control Word with bit 11=1 within the timeout set in parameter R016 . To disable this fault, set parameter R016 to 0.  NOTE The counter starts only when the drive receives the first Control Word with bit 11=1.  NOTE
		0	Inactive communication: once activated, the watchdog counter increases up to the value set in R016 .
12 to 15			Not used.

Table 6: The Control Word (PROFIBUS Parameter 967).



NOTE The upper case boldface text refers to the states shown in Figure 7.

Bit	Name	Value	STATE/Description
0	RDY_ON	1	READY TO SWITCH ON
		0	NOT READY TO SWITCH ON
1	RDY_RUN 1	1	READY TO OPERATE
		0	OFF1 ACTIVE
2	RDY_REF 1	1	ENABLE OPERATION (drive follows setpoint)
		0	DISABLE OPERATION
3	TRIPPED 1	1	FAULT
		0	No fault
4	OFF_2_STA	1	OFF2 (Coast Stop) inactive
		0	OFF2 (Coast Stop) ACTIVE
5	OFF_3_STA 1	1	OFF3 (Quick Stop) inactive
		0	OFF3 (Quick Stop) ACTIVE

6	SWC_ON_INHIB	1	SWITCH-ON INHIBIT ACTIVE
		0	SWITCH-ON INHIBIT NOT ACTIVE
7	ALARM	1	Warning/Alarm
		0	No Warning/Alarm
8	AT_SETPOINT	1	OPERATING. Actual speed equals reference value (i.e. is within tolerance limits).
		0	Actual speed differs from reference value (= is outside tolerance limits).
9	REMOTE	1	Control Requested (Control By PLC): at least one between Selection of Command Source (C140..C142) and Selection of Reference Source (C143..C146) is sent from Fieldbus
		0	No Control Requested (No Control By PLC).
10 to 15			Not used.

Table 7: The Status Word (PROFIBUS Parameter 968).



NOTE The upper case boldface text refers to the states shown in Figure 7.



NOTE When the ENABLE contact in the terminal board opens (this contact is required for the operation of the Sinus Penta), the state allocated to bit 6 - **SWITCH-ON INHIBIT ACTIVATED** is enabled.

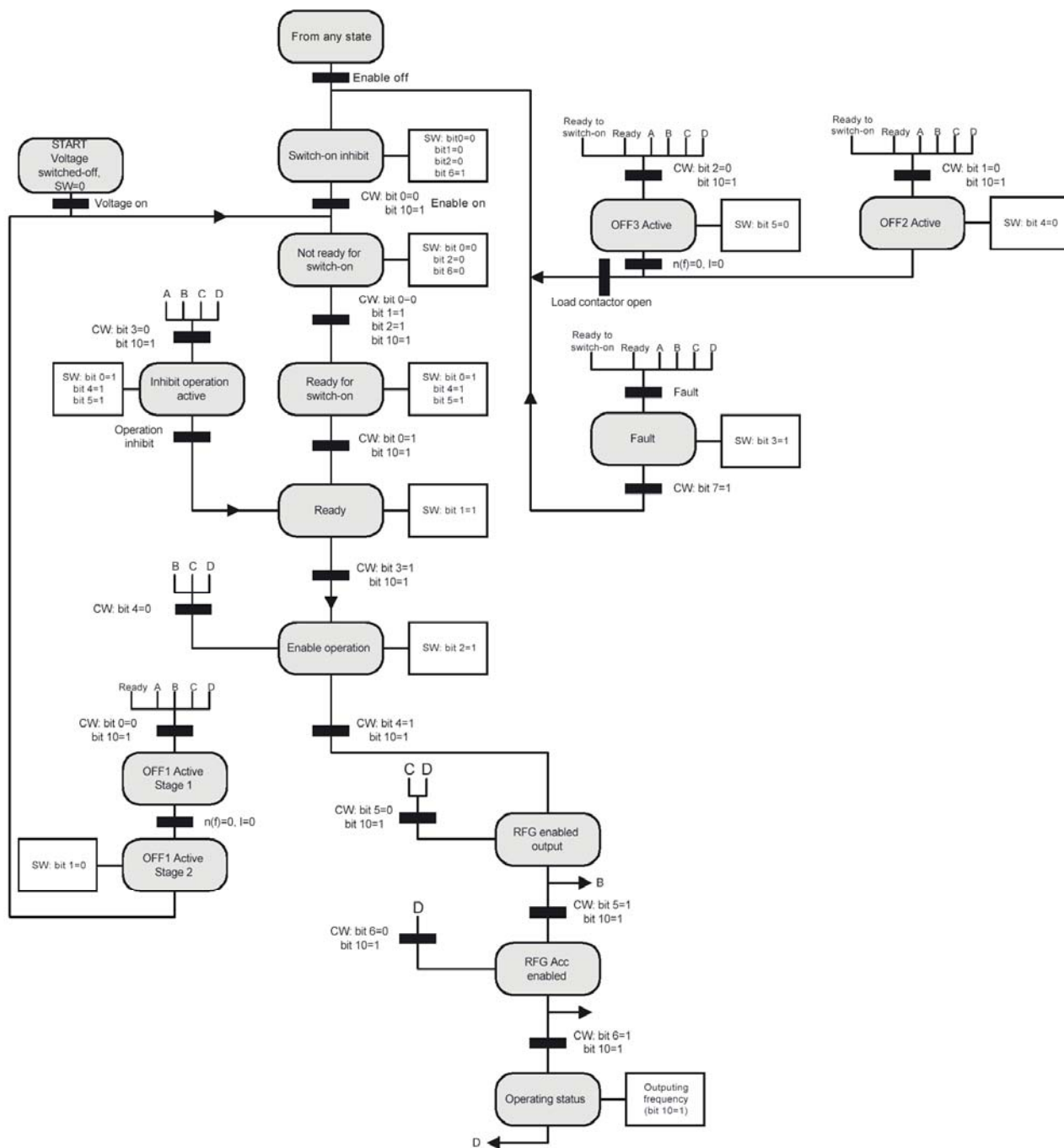

P000801-B

Figure 7: The PROFdrive state machine.

DP-V1 Read/write Request Sequence

A read/write service on a drive parameter is illustrated below.

P000808-B

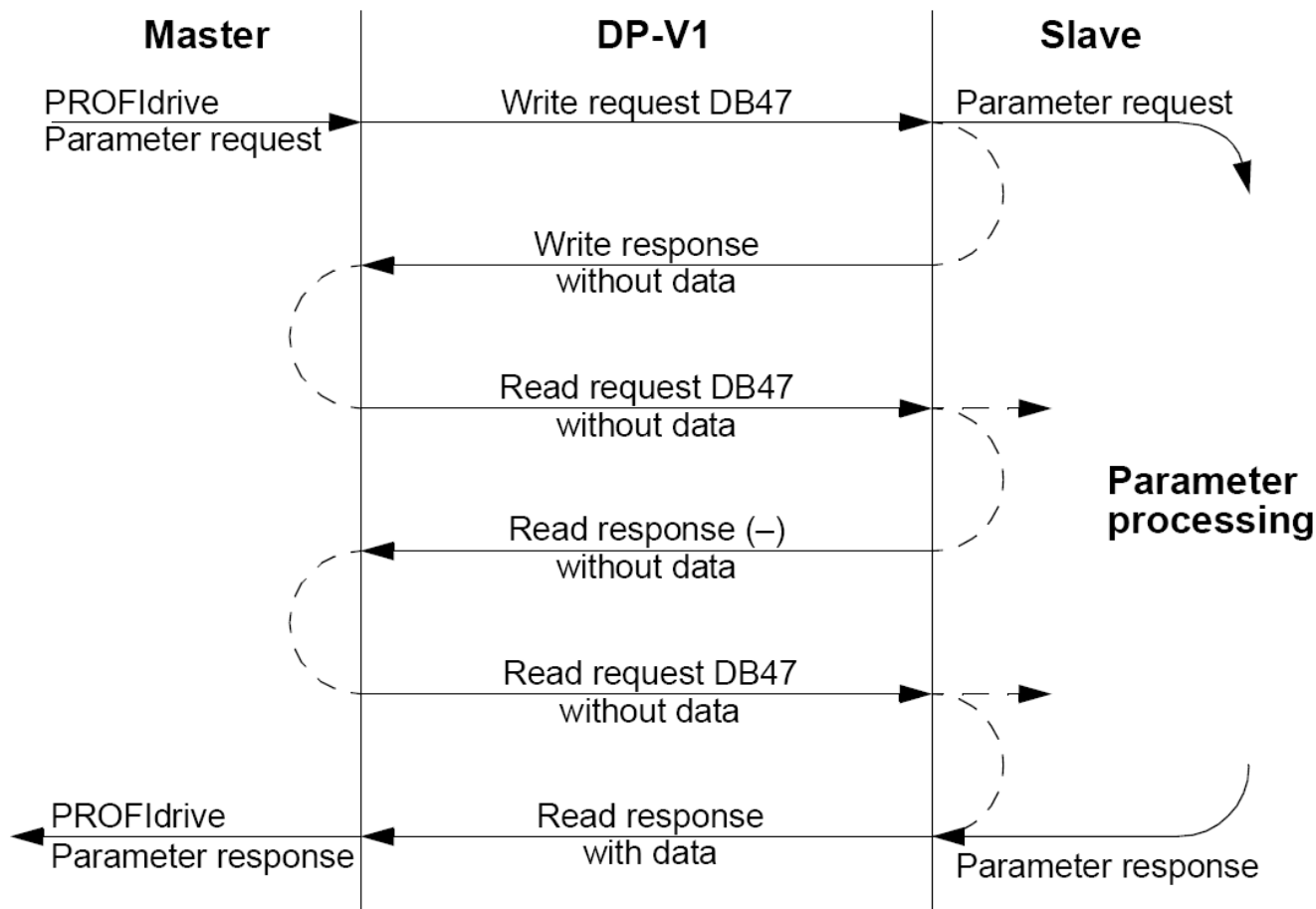

The messaging employs DP-V1 data units. The PROFIdrive parameter request is contained within the DP-V1 request as data.

Likewise, the DP-V1 response contains the PROFIdrive parameter response as data.

A write request (Function number 5Fh – see Table 8 below) is first sent containing the parameter request.

If the write request is valid, the PROFIdrive board acknowledges it with DPV1 write response code 5Fh with no data. The master will then send a read request. If the PROFIdrive board is still busy performing the internal parameter request, it will return a negative response with the DP-V1 error code B5h (State conflict). In this case, the read request will be repeated by the master until the PROFIdrive board has the PROFIdrive response data ready.

If the write request is invalid, a negative response is returned with a DP-V1 error code (see Table 10).

PROFIBUS SD2 Telegram for SAP 51

The Read/Write service uses a variable-length PROFIBUS SD2 telegram shown below.

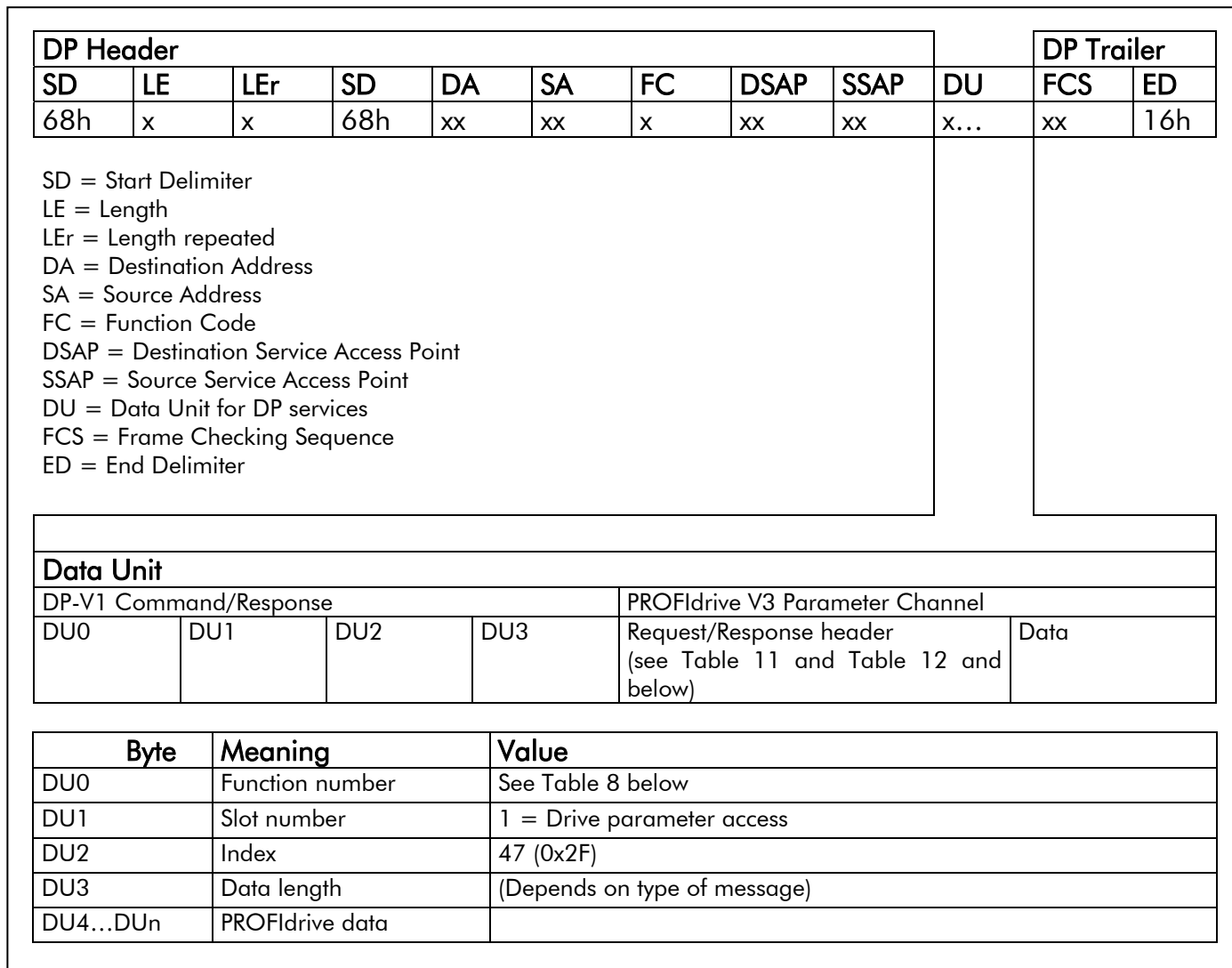

Figure 8: PROFIBUS SD2 telegram.

Value	Meaning
0x48	Idle REQ, RES
0x51	Data transfer REQ, RES
0x56	Resource manager REQ
0x57	Initiate REQ, RES
0x58	Abort REQ
0x5C	Alarm REQ, RES
0x5E	Read REQ, RES
0x5F	Write REQ, RES
0xD1	Data transfer negative response
0xD7	Initiate negative response
0xDC	Alarm negative response
0xDE	Read negative response
0xDF	Write negative response

Table 8: DP-V1 function numbers- byte DU0

Byte	Meaning and value
DU0	Function number = 0xDF (Error Write) = 0xDE (Error Read)
DU1	Error Decode = 0x80 (DP-V1) PROFdrive: Always 128 (DP-V1 codes)
DU2	Error Code 1: Error class/error code (see Table 10 below)
DU3	Error Code 2: Always 0

Table 9: DP-V1 error response.

MSB=7 LSB=0							
X	X	X	X	X	X	X	X
Bits 5 - 7				Bits 0 - 4			
Error Class and Meaning				Error Code and Meaning			
0...9 = (Reserved)				-			
10 (0x0A) = Application				0 = Read error 1 = Write error 2 = Module failure 3 ... 7 = Reserved 8 = Version conflict 9 = Feature not supported 10 ... 15 = User-specific			
11 (0x0B) = Access				0 = Invalid index 1 = Write length error 2 = Invalid slot 3 = Type conflict 4 = Invalid area 5 = State conflict 6 = Access denied 7 = Invalid range 8 = Invalid parameter 9 = Invalid type 10 ... 15 = User-specific			
12 (0x0C) = Resource				0 = Read constraint conflict 1 = Write constraint conflict 2 = Resource busy 3 = Resource unavailable 4 ... 7 = Reserved 8 ... 15 = User-specific			
13 ... 15 = User-specific				-			

Table 10: DP-V1 error response: Error codes – byte DU2.

Field(s)	Description	Range	Byte/ Word
Request Reference	Unique identification set by the master. Changed for each new request.	1 ... 255	Byte
Request ID	Request type for the issued block.	Request Parameter (01h) Change Parameter (02h)	Byte
Axis	To be set to 0 or 1.	0 ... 255	Byte
No. of Parameters	Number of parameters that are present in the request.	1 ... 37	Byte
Attribute	Type of object being accessed.  NOTE "Text" is not supported.	Value (10h) Description (20h) Text (30h)	Byte
No. of Elements	Number of array elements accessed or length of string accessed. Set to 0 if non-array parameters are used.	0, 1 ... 234 Byte	Byte
Parameter Index	Address of the parameter that is being accessed. "0" is allowed by RPBA-01.	1 ... 65535 Word	Word
Subindex	Addresses the first array element of the parameter or the beginning of a string access or the text array, or the description element that is being accessed.	0 ... 65535 Word	Word
Format*	See Table 12	See Table 12	Byte
Number of Values*	Number of values following.	0 ... 234	Byte
Values*	The values of the request. In case of odd number of bytes, a zero byte is appended to ensure the word structure of the telegram.	–	See Format field
*Only if Request ID is 02h (Change Parameter). The Format, Number of Values and Values fields are repeated for other parameters.			

Table 11: PROFdrive Request header.

Field(s)	Description	Range
Response Reference	Mirrored from the request.	1 ... 255
Response ID	Response from the slave. In case any requested services fail, a "not acknowledged" (NAK) response will be indicated.	Request Param OK (01h) Request Param NAK (81h) Change Param OK (02h) Change Param NAK (82h)
Axis	To be set to 1.	0 ... 255
No. of Parameters	Number of parameters that are present in the response.	1 ... 37
Format*	See Table 13.	See Table 13.
Number of Values*	Number of values following.	0 ... 234
Values*	The values of the request. In case of odd number of bytes, a zero byte is appended to ensure the word structure of the telegram.	-
*Only if Response ID is 01h (Request Parameter OK). The Format, Number of Values and Values fields are repeated for other parameters.		

Table 12: PROFIdrive Response header.

Code	Type
0x00	(Reserved)
0x01 ... 0x36	Standard data types
0x37 ... 0x3F	(Reserved)
0x40	Zero
0x41	Byte
0x42	Word
0x43	Double word
0x44	Error
0x45 ... 0xFF	(Reserved)

Table 13: Data types for Format field.

Error #	Meaning	Used at
00h	Impermissible parameter number	Access to unavailable parameter
01h	Parameter value cannot be changed	Change access to a parameter value that cannot be changed
02h	Low or high limit exceeded	Change access with value outside the limits
03h	Invalid subindex	Access to unavailable subindex
04h	No array	Access with subindex to non-indexed parameter
05h	Incorrect data type	Change access with value that does not match the data type of the parameter
06h	Setting not permitted (can only be reset)	Change access with value unequal to 0 when this is not permitted
07h	Description element cannot be changed	Change access to a description element that cannot be changed
09h	No description data available	Access to unavailable description (parameter value is available)
0Bh	No operation priority	Change access rights without rights to change parameters
0Fh	No text array available	Access to text array that is not available (parameter value is available)
11h	Request cannot be executed because of operating mode	Access is temporarily not possible for reasons that are not specified in detail
14h	Value impermissible	Change access with a value that is within limits but is not permissible for other long-term reasons (parameter with defined single values)
15h	Response too long	The length of the current response exceeds the maximum transmittable length
16h	Parameter address impermissible	Illegal value or value that is not supported for the attribute, number of elements, parameter number or subindex, or a combination
17h	Illegal format	Write request: Illegal format or format of parameter data that is not supported
18h	Number of values inconsistent	Write request: Number of values of parameter data does not match number of elements at the parameter address
65h ... FFh	Manufacturer-specific	–
65h	Vendor-specific error	Vendor-specific error
66h	Request not supported	Request not supported
67h	Communication error	Request cannot be completed because of communication error
68h ... 6Dh	Manufacturer-specific	–
6Eh	Non-volatile error	Failure during write to non-volatile memory
6Fh	Time-out error	Request aborted because of timeout

70h ... 77h	Manufacturer-specific	-
78h	PZD map failure	Parameter cannot be mapped to PZD (size mismatch or non-existent)
79h	PZD memory failure	Parameter cannot be mapped to PZD (out of memory)
7Ah	Multiple PZD map	Parameter cannot be mapped to PZD (multiple PZD write)
7Bh ... 81h	Manufacturer-specific	-
82h	Control word bit map	Cannot map Control word bit (parameter 933...937, e.g. double mapping of bits)
83h ... 8Bh	Manufacturer-specific	-
8Ch	Set torque mode error	Cannot change mode to TORQUE (frequency is used)
90h	Illegal Request ID	The request ID of the response is illegal
8Dh ... FFh	Manufacturer-specific	-

Table 14: PROFIdrive Parameter Request error codes.

Parameter data transfer examples

The following examples show how parameter data is transferred using the DP-V1 mechanisms READ and WRITE.



NOTE Only the "Data unit" part of the SD2 telegram is presented in the examples. See Figure 8.

Example 1a: Reading a drive parameter

To determine the parameter number and subindex for drive parameter reading, check for the parameter address in the drive software manual and divide it by 100.

M026 Output Current

M026	Range		
	Active		
	Address	1676	
	Function		

The integer part is the parameter number (PNU), the remaining part (decimal part) is the subindex (IND). For example, reading parameter **M026** Output Current (address = 1676) from the drive:

Parameter number is 16 (10h) and subindex is 76 (48h).

DP-V1 Write request (Read parameter value):

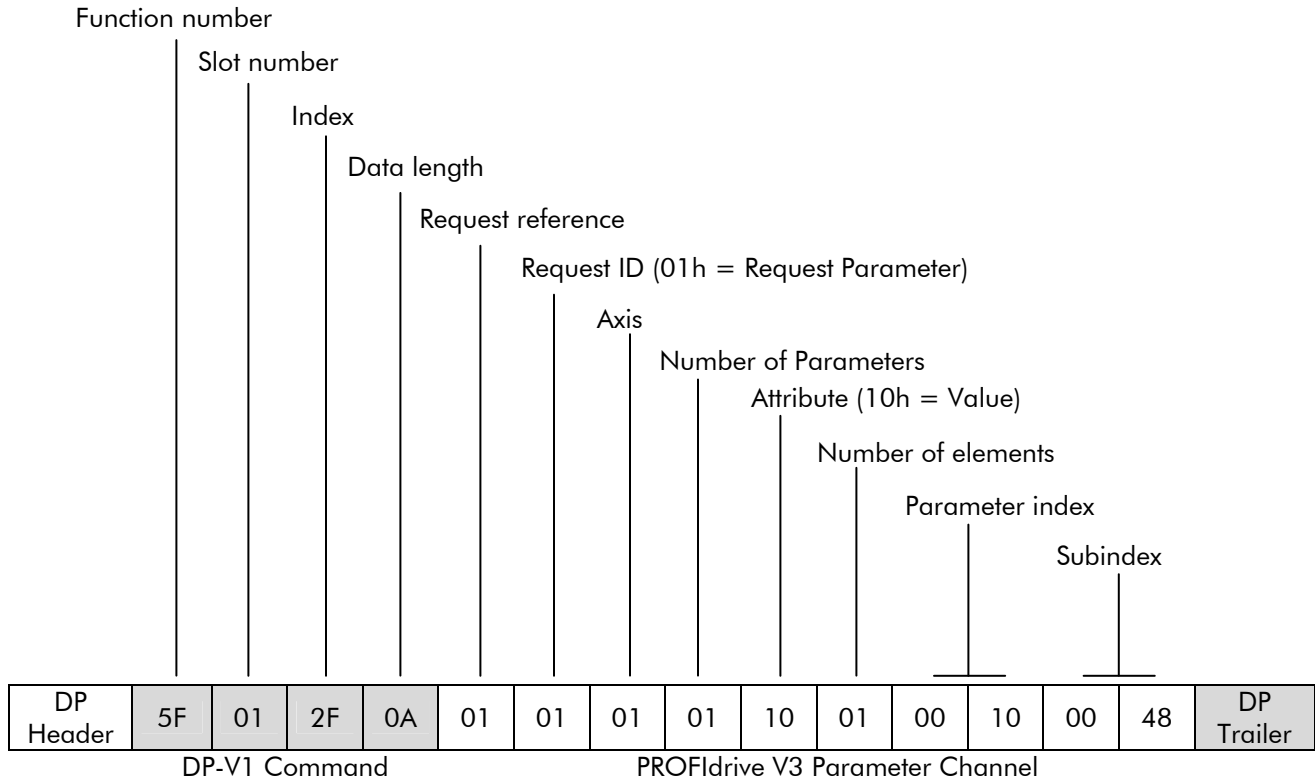

Positive Read response to DP-V1 Read request:

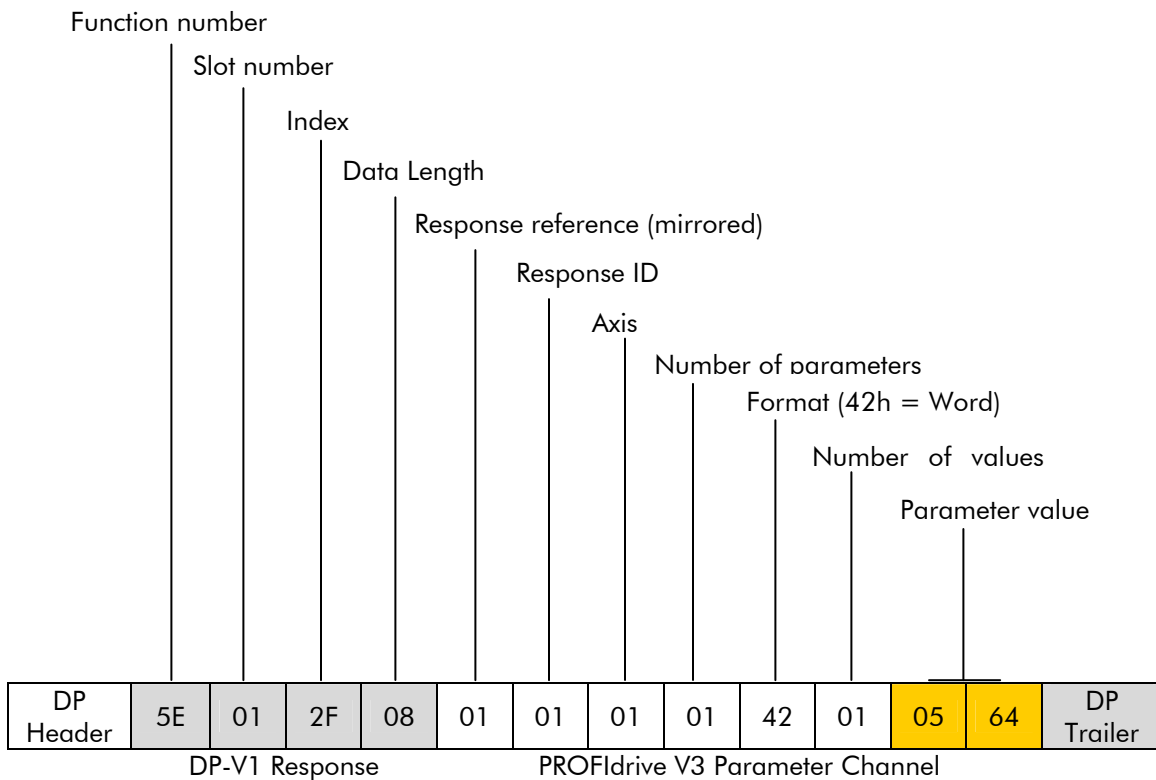

Negative response to PROFdrive Read request:

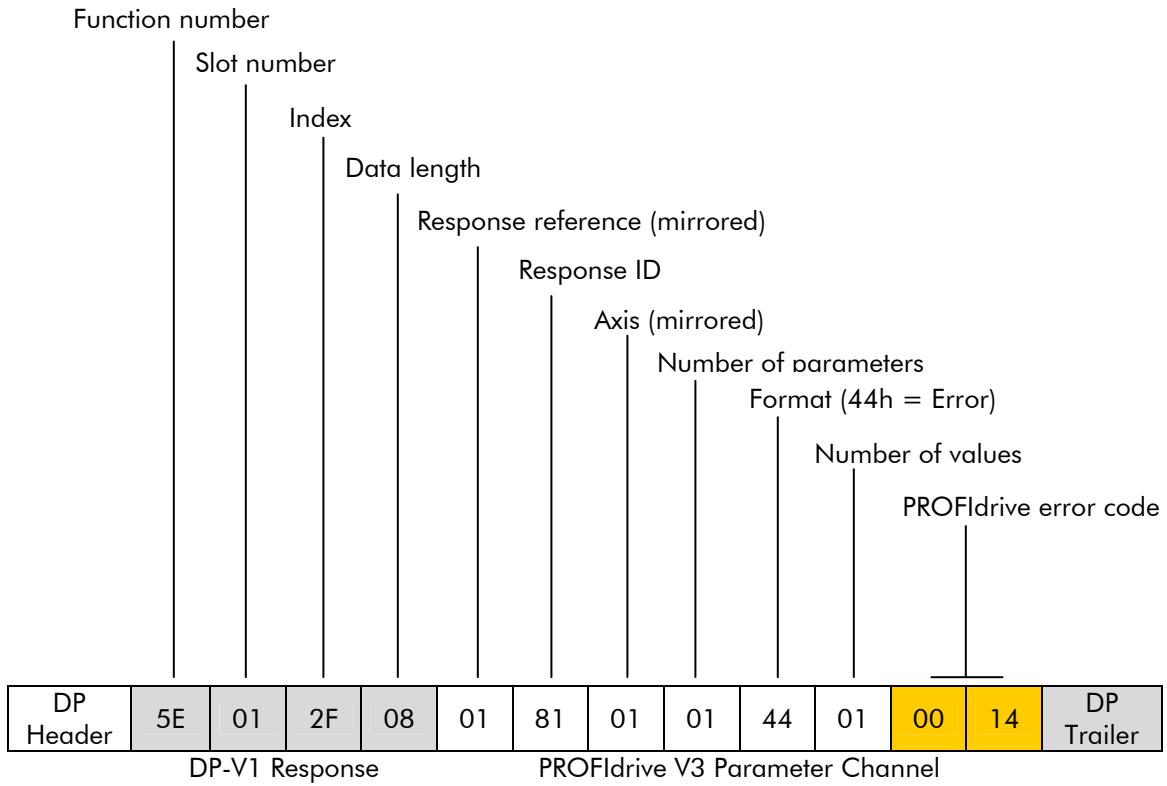

Example 2a: Writing a drive parameter

To determine the parameter number and subindex for drive parameter writing, check for the parameter address in the drive software manual and divide it by 100. The resulting quotient (integer part) is the parameter number (PNU) and the remaining part (decimal number) is the subindex (IND).

For example write parameter **P009** Speed Ramp 1 – Acceleration Time (address = 609) as 100 (64h):

Parameter number is 6 (06h) and subindex is 9 (09h).

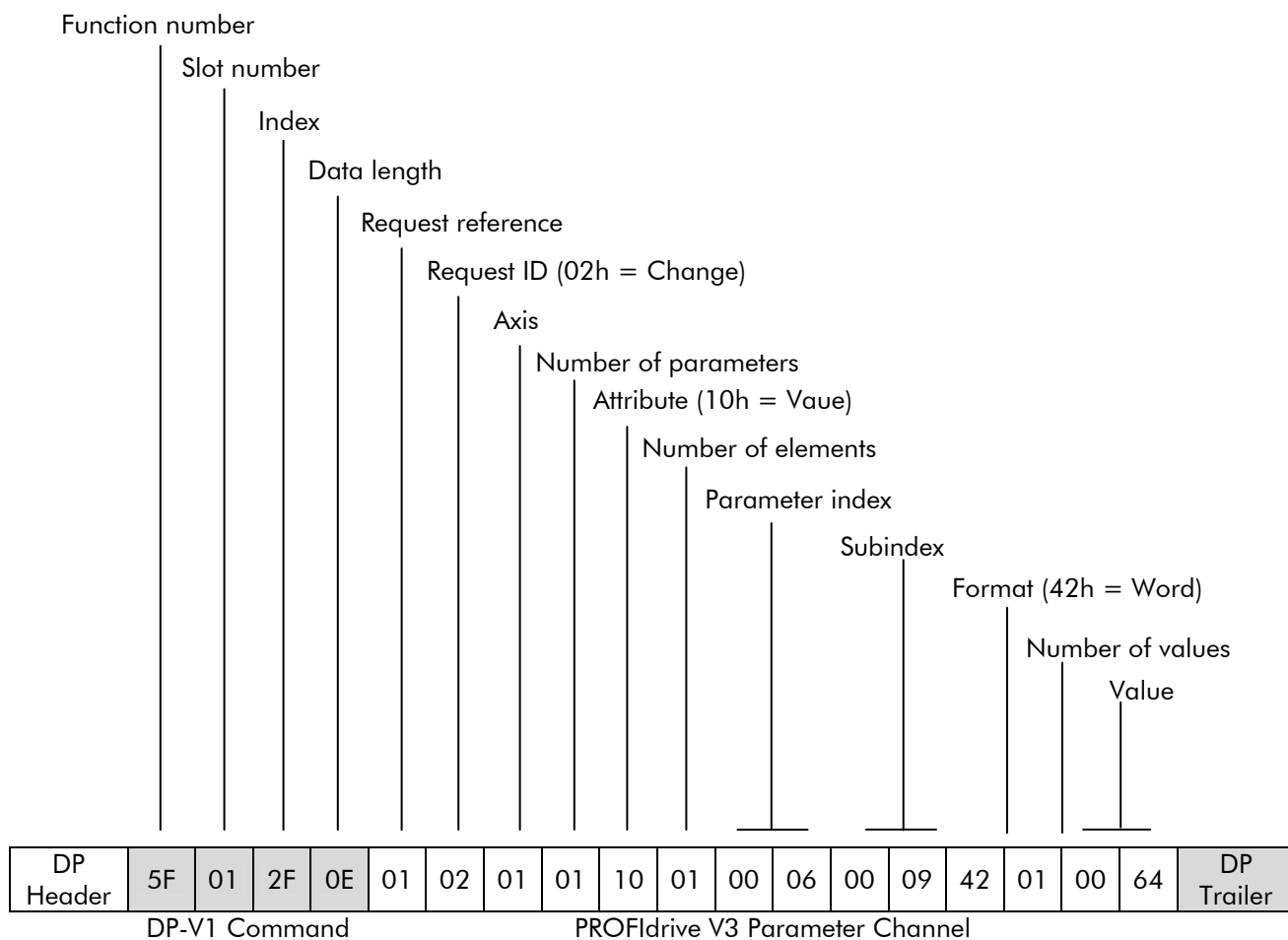

Responses to DP-V1 Write request:

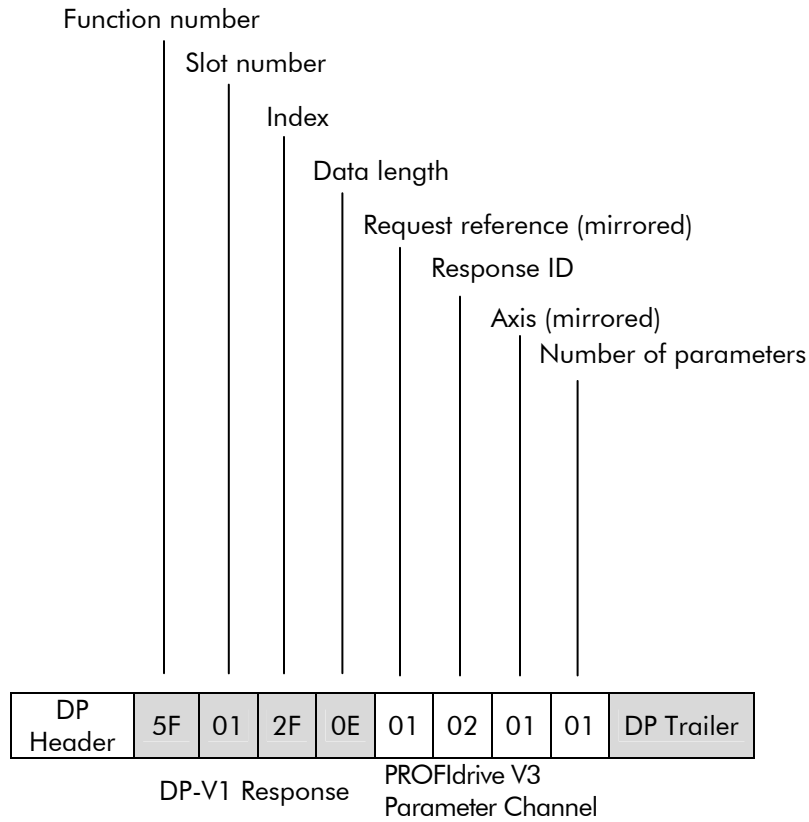

8. FAULT TRACING

8.1. LED INDICATIONS

The PROFIdrive communications board is equipped with four diagnostic LEDs.
The description of the LEDs is below.

Name	Colour	Function
ERROR	Red	<p>Flashing 1 Hz - Error in configuration: Internal configuration mismatch.</p> <p>Flashing 2 Hz - Error in User Parameter data: The length/contents of the User Parameter data set during initialisation of the module is not equal to the length/contents set during configuration of the network. Check that the selected DP mode matches the GSD file used (see configuration parameter R044 DP Communication Mode).</p> <p>Flashing 4 Hz - Error in initialisation of the PROFIBUS communication ASIC.</p> <p>Off - No diagnostics present</p>
On-Line	Green	<p>Lit - Module is On-Line and data exchange is possible.</p> <p>Off - Module is not On-Line.</p>
Off-Line	Red	<p>Lit - Module is Off-Line and no data exchange is possible.</p> <p>Off - Module is not Off-Line.</p>
Host Indication	Green	<p>Lit - Link functional.</p>
	Red	<p>Lit - Link lost permanently.</p> <p>Flashing - Link lost temporarily.</p>

9. PROFIDRIVE PARAMETERS

Parameter	R/W	Data type	Description
915	R/W	Array [10] Unsigned16	Assignment PZD1 to PZD10 in PPO-write
916	R/W	Array [10] Unsigned16	Assignment PZD1 to PZD10 in PPO-read
918	R/W	Unsigned16	Node address. Writing this parameter will change the node address if the rotary switches have the setting 0. Module start required
919	R	Octet String4	Device system number.
927	R/W	Unsigned16	Operator control rights (parameter identification, PKW). Value Mode 0 Parameters cannot be written, only read (927 can be written) 1 Parameters can be written and read (default).
928	R/W	Unsigned16	Control rights (process data, PZD). Value Mode 0 PZD part is disabled, i.e. Receipt of new PZD data is ignored. 1 PZD part is enabled (default).
929	R	Unsigned16	Selected PPO-type. Value PPO-Type Configuration 1 PPO1 F3h, F1h 2 PPO2 F3h, F5h 3 PPO3 F1h 4 PPO4 F5h 5 PPO5 F3h, F9h 6 PPO6 F9h
930	R	Unsigned16	Selected operation mode. Value Mode 1 Speed control mode: Control word and status word for frequency/speed used. 8001h Speed control mode: Control word and status word for torque used.

933	R/W	Unsigned16	<p>Selection switch for Control word, bit 11.</p> <p>Value Control word bit</p> <p>0 None</p> <p>1 to 5 Vendor specific 1 to 5*</p> <p>* The meaning of vendor specific bits is defined by the drive application program. See WATCHDOG (Control Word bit 11 – Table 4 or Table 6)</p> <p> NOTE For the correct operation of the WATCHDOG, this parameter must be set to 2.</p>
947	R	Array[64] Unsigned16	<p>Fault code (coded according to DRIVECOM profile – see Sinus Penta’s Programming Instructions manual).</p> <p>Subindex Contents</p> <p>1 Active Fault</p> <p>9 Last ackn. Fault</p> <p>17 Second last ackn. Fault</p> <p>25 Third last ackn. Fault</p> <p>33 Fourth last ackn. Fault</p> <p>41 Fifth last ackn. Fault</p>
953	R	Unsigned16	Last alarm (meaning is vendor specific)
954	R	Unsigned16	Second last alarm
955	R	Unsigned16	Third last alarm
956	R	Unsigned16	Fourth last alarm
957	R	Unsigned16	Fifth last alarm
961	R	Octet String4	<p>Hardware configuration (manufacturer specific ID of the drive)</p> <p>bit 0..3 Fan Control</p> <p>bit 4..7 Voltage Class</p> <p>bit 8..15 Drive Size as shown in the Product Name and Type page of the IDP Menu (see Sinus Penta’s Programming Instructions manual).</p>

963	R	Unsigned16	<p>Baud rate:</p> <p>0 12 Mbit/s</p> <p>1 6 Mbit/s</p> <p>2 3 Mbit/s</p> <p>3 1.5 Mbit/s</p> <p>4 500 kbit/s</p> <p>5 187.5 kbit/s</p> <p>6 93.75 kbit/s</p> <p>7 45.45 kbit/s</p> <p>8 19.2 kbit/s</p> <p>9 9.6 kbit/s</p> <p>255 Invalid baud rate</p>
964	R	Unsigned16	Identification number of this device (0401h)
965	R	Octet String2	Profile number of this device (0302h) Profile Version 3 2
967	R	Unsigned16	Control word (CW)
968	R	Unsigned16	Status word (SW)
970	R/W	Unsigned16	<p>Load parameter record</p> <p>Value Description</p> <p>0 No action</p> <p>1 Restore factory settings. The parameter must do a zero-to-one transition and the motor must be stopped.</p>
971	R/W	Unsigned16	<p>Save parameter records</p> <p>Value Description</p> <p>0 No action</p> <p>1 Save the drive parameters to non-volatile memory. The parameter must do a zero-to-one transition and the motor must be stopped.</p>

Table 15: PROFdrive profile-specific parameters.

10. DEFINITIONS AND ABBREVIATIONS

10.1. PROFIBUS DEFINITIONS

Acyclic Communication	Communication in which messages are sent only once on request
Array	Parameter consisting of data fields of equal data type
Broadcast	Non-acknowledged message from master to all bus participants (compare Multicast)
Command Word	See Control Word
Communication Object	Any object of a real device that can be communicated with (variable, program, data range, etc.). Stored locally in the Object Dictionary.
Control Word	16-bit word from master to slave with bit-coded control signals (sometimes called the Command Word).
Cyclic Communication	Communication in which Parameter-/Process Data-Objects are sent cyclically at pre-defined intervals
Device Class	Classification according to the number of profile functions included in the device
Drivecast	Broad- and Multicast, a special message frame for drives
Fault	Event that leads to tripping of the device
GSD File	ASCII-format device description file in a specified form. Each device (active & passive stations) on PROFIBUS has to have its own GSD File.
Index	Access reference for Objects in PROFIBUS
Information Report	Non-acknowledged message from master to one or all groups of bus participants
Master	Control system with bus initiative. In PROFIBUS terminology, master stations are also called active stations.
Multicast	Non-acknowledged message from master to one group of bus participants (compare Broadcast)
Name	Symbolic name of a parameter
Nibble	Set of 4 bits
Object Dictionary	Local storage of all Communication Objects recognised by a device
Object List	List of all accessible objects
Parameter	Value that can be accessed as Object, e.g. variable, constant, signal
Parameter Number	Parameter address
Parameter/Process Data Object	Special object that contains Parameter and Process Data
Process Data	Data that contains Control Word and Reference value or Status Word and Actual value. May also contain other (user-definable) control information.
Profile	Adaptation of the protocol for certain application field, e.g. drives

Request Label	Coded information specifying the required service for the parameter part sent from master to slave
Response Label	Coded information specifying the required service for the parameter part sent from slave to master
Slave	Passive bus participant. In PROFIBUS terminology, slave stations (or slaves) are also called passive stations. Also referred to as node.
Status Word	16-bit word from slave to master with bit-coded status messages
Warning	Signal caused by an existing alarm which does not lead to tripping of the device

10.2. PROFIBUS ABBREVIATIONS

The **bold face** text is the original German term.

.con	Confirmation
.ind	Indication
.req	Request
.res	Response
ACT	Actual Value Istwert
AK	Request Label/Response Label Auftragskennung/Antwortkennung
ALI	Application Layer Interface
CR	Communication Reference Kommunikationsreferenz (Kommunikationsbeziehung)
DP	Decentralised Periphery Dezentrale Peripherie
DP-ALI	Application Layer Interface for DP
DP-V1	PROFIBUS DP Extensions to the EN 50170 standard, including e.g. acyclic data exchange
FDL	Fieldbus Data Link
FMS	Fieldbus Message Specification
FSU	Manufacturer Specific Interface Firmenspezifischer Umsetzer
HIW	Main Actual Value Hauptistwert
HSW	Main Reference Hauptsollwert
ISW	see ACT
KR (KB)	see CR
PA	Process Automation Prozessautomatisierung
PD	Process Data Prozessdaten
PKE	Parameter Identification Parameter-Kennung
PKW	Parameter Identification Value Parameter-Kennung-Wert
PNU	Parameter Number Parameternummer
PPO	Parameter/Process Data Object Parameter-/Prozessdaten-Objekt
PWE	Parameter Value Parameter-Wert
PZD	see PD

PZDO	Process Data Object Prozessdatenobjekt
SAP	Service Access Point
SOW	Reference Sollwert
SPM	Request Signal Spontanmeldung
STW	Control Word Steuerwort
ZSW	Status Word Zustandswort

11. TECHNICAL DATA

11.1. PROFdrive COMMUNICATIONS BOARD

Mounting: Into the option slot "B" on the control board of the drive.

Degree of protection: IP20

Ambient conditions: The applicable ambient conditions specified for the drive in its *Installation Instructions* manual are in effect.

Hardware settings:

Rotary switches for node address selection (address range 00 to 99)
DIP switch for bus termination selection

Software settings:

- Input/Output/User Parameter data/Diagnostics format
- Maximum cyclic I/O data size: 28 bytes in, max 28 bytes out, max. 56 bytes total
- Maximum acyclic I/O data size: 240 bytes in, max. 240 bytes out, max. 480 bytes total
- Maximum User Parameter data/Diagnostics length: 26 bytes

Connectors:

- 34-pin parallel bus connector
- 9-pin female DSUB connector

Current consumption:

- 350 mA max. (5 V), supplied by the control board of the drive

General:

- Estimated min. lifetime: 100 000 h
- All materials UL/CSA-approved
- Complies with EMC standards EN 50081-2 and EN 50082-2

11.2. PROFIBUS LINK

Compatible devices: All devices compatible with the PROFIBUS DP protocol

Size of the link: 127 stations including repeaters (31 stations and 1 repeater per segment)

Medium: Shielded, twisted pair RS-485 cable – “Profibus bus Cable Type A” approved.

- Termination: built in the module
- Specifications:

Parameter	Line A PROFIBUS DP	Unit
Impedance	135 to 165 (3 to 20 MHz)	Ω
Capacitance	< 30	pF/m
Resistance	< 110	Ω /km
Wire gauge	> 0.64	mm
Conductor area	> 0.34	mm ²

Maximum bus length:

Transfer rate (kbit/s)	≤ 93.75	187.5	500	1500	3000	6000	12000
Line A (m)	1200	1000	400	200	100	100	100

Topology: Multi-drop – “Profibus FC” TWO WAY connectors are recommended.

Serial communication type: Asynchronous, half Duplex

Transfer rate: 9.6 kbit/s, 19.2 kbit/s, 45.45 kbit/s, 93.75 kbit/s, 187.5 kbit/s, 500 kbit/s, 1.5 Mbit/s, 3 Mbit/s, 6 Mbit/s, or 12 Mbit/s (automatically detected by PROFdrive communications board)

Protocol: PROFIBUS DP.